

i-NEXT DW

3 – 150 kW

FULL INVERTER direct expansion air conditioners for IT Cooling
Equipped with built-in water-cooled condenser



The picture of the unit is indicative and may vary depending on the model

- PERIMETER INSTALLATION
- FULLY HERMETIC BLDC INVERTER COMPRESSORS
- SINGLE OR DOUBLE REFRIGERANT CIRCUIT
- AIR DELIVERY FROM THE BOTTOM (UNDER) OR FROM THE TOP (OVER)
- PLUG FANS WITH EC ELECTRIC MOTOR
- ELECTRONIC EXPANSION VALVE
- AIR SUCTION TEMPERATURE UP TO 40°C

Data Book: T_iNEXTDW_1118_EN

INDEX

MEHITS CERTIFICATIONS	3
GENERAL CHARACTERISTICS	4
INSTALLATION	5
PRODUCT FEATURES AND BENEFITS	5
F-GAS DIRECTIVE	5
MODEL IDENTIFICATION	6
STORING TEMPERATURE	6
WORKING LIMITS	7
MAIN COMPONENTS	8
OPTIONAL ACCESSORIES	10
TECHNICAL DATA	11
REFRIGERANT CIRCUIT	16
WATER QUALITY	18
ACOUSTIC DATA	19
ELECTRICAL DATA	19
MICROPROCESSOR CONTROL SYSTEM	20
POSSIBLE AIR INTAKE FOR OVER VERSIONS	22
OPTIONAL ACCESSORIES – DOUBLE POWER SUPPLY WITH AUTOMATIC TRANSFER SWITCH	23
OPTIONAL ACCESSORIES – NETWORK ANALYZER	24
OPTIONAL ACCESSORIES – FIRE / SMOKE SENSORS	25
OPTIONAL ACCESSORIES - CONDENSATE DISCHARGE PUMP	26
OPTIONAL ACCESSORIES – MODULATING STEAM HUMIDIFIER	27
OPTIONAL ACCESSORIES – DEHUMIDIFICATION SYSTEM	29
OPTIONAL ACCESSORIES - 2-WAY MOTORIZED VALVE FOR CONDENSING CONTROL	29
OPTIONAL ACCESSORIES – ELECTRIC HEATERS	30
OPTIONAL ACCESSORIES - HOT GAS RE-HEATING SYSTEM	31
OPTIONAL ACCESSORIES – HOT WATER HEATING SYSTEM	33
OPTIONAL ACCESSORIES - FLOOR STAND	36
OPTIONAL ACCESSORIES - DOUBLE PANELS IN EUROCLASS A1	37
OPTIONAL ACCESSORIES – EPM ₁₀ 50% EFFICIENCY AIR FILTERS	37
OPTIONAL ACCESSORIES – NON-RETURN MOTORIZED DAMPER	38
OPTIONAL ACCESSORIES - PLENUM ON AIR DELIVERY/RETURN	40
OPTIONAL ACCESSORIES – DIRECT FREE-COOLING PLENUM	48
OPTIONAL ACCESSORIES – BOTTOM PANEL FOR OVER VERSION	51
OPTIONAL ACCESSORIES – KIPLINK – KEYBOARD IN YOUR POCKET	51
OPTIONAL ACCESSORIES – CLOUD PLATFORM: WEB SERVICES BASED ON CLOUD TECHNOLOGY FOR REMOTE MONITORING AND MANAGEMENT OF AIR CONDITIONING PLANTS	52
MACHINE DRAWINGS	53
HOLE IN THE RAISED FLOOR FOR DOWNFLOW VERSION	68
EXAMPLE FOR MACHINES NOISE EMISSION CALCULATION	69
VALVE PRESSURE DROP CALCULATION AS FUNCTION OF WATER FLOW RATE	71
AIR FILTERS REPLACEMENT	72

MEHITS CERTIFICATIONS

SYSTEM CERTIFICATIONS



ISO 9001 CERTIFICATION – MEHITS S.p.A.
Quality Management System



ISO 14001 CERTIFICATION – MEHITS S.p.A.
Environmental Management System



BS OHSAS 18001 CERTIFICATION – MEHITS S.p.A.
Occupational Health and Safety Management System

PRODUCT CERTIFICATIONS BY COUNTRY



CE MARKING
MEHITS units are in compliance with the European Directives in force.



CCC – CQC CERTIFICATION
(People's Republic of China)



EAC CERTIFICATION
(Russian Federation, Belarus, Kazakhstan)



GENERAL CHARACTERISTICS



UNDER
Downflow air delivery



OVER
Upflow air delivery

FULL INVERTER Air Conditioners for IT Cooling.

- Direct expansion, water cooled.
- Equipped with built-in water cooled condenser
- BLDC inverter compressors.
- Plug fans with EC electric motor.
- Single or double refrigerant circuit.

This series is offered in 10 models available in the following versions:

- The upflow version (Over) is characterized by air intake from the front through honeycomb grille and air delivery from the top of the unit.
- The downflow version (Under) is characterized by air intake from the top and air delivery from the bottom of the unit.

Cooling capacity: 3 ÷ 150 kW

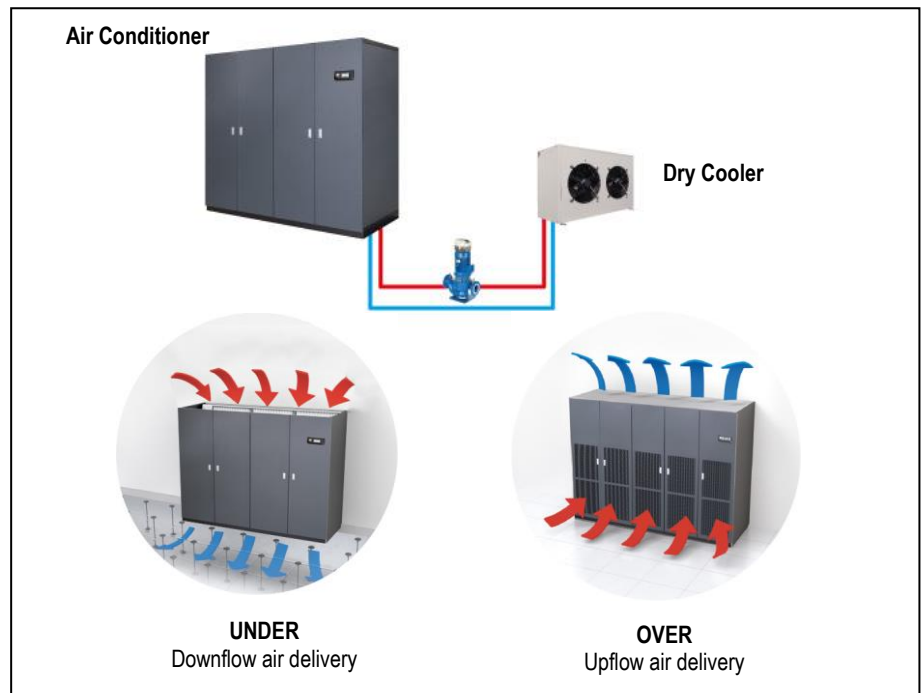

The machines are made for indoor installation.

The constructive solutions and the internal lay-out allow high application flexibility and the frontal access to the main components for the inspection and routine maintenance.

The installation requires electrical and hydraulic connections.

Final assembly on all machines before shipment including running test, reading and monitoring of operating parameters, alarms simulation and visual check.



INSTALLATION

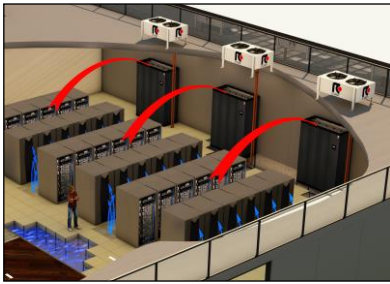

The series is particularly suitable for installation in Data Center of medium / small size with variable load.

DOWNFLOW VERSION (Under)

Typical installation is on the perimeter.

The units are placed along the perimeter of the data center. Air suction from the top of the unit and air delivery in the underfloor void.

The air distribution is achieved by special tiles placed in front of the racks row, forming cold aisle for air diffusion. On the rear of the racks is expelled the hot then aspirated by the unit.

For an optimal installation is advisable to provide the cold aisle containment.



Some solutions provide a service corridor around the server rooms where to place the units. In this case it is necessary to provide the air intake plenum for each unit. With this solution all the space in the Data Center is available for the installation of racks.

UPFLOW VERSION (Over)

The type of installation is practically similar to the previous. The only difference is that for the air distribution in the Data Center is not used the raised floor but ducts in the ceiling.

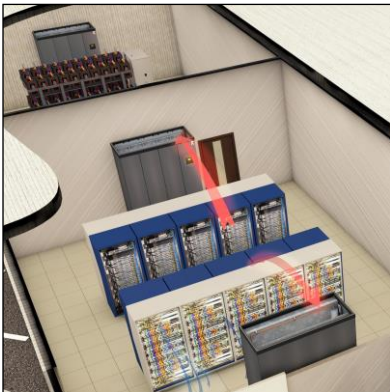

The series is also suitable for installation in UPS, Batteries, Distribution rooms and in all service areas of the data center that need a service of conditioning.

OPTIONAL

An extensive list of accessories allows the unit to adapt effectively to the real needs of the system, reducing the time and cost of installation.

PRODUCT FEATURES AND BENEFITS

- EER up to 8,17 at partial load;
- Single BLDC scroll inverter compressor for each refrigerant circuit in order to provide always the best efficiency;
- New plug fans with EC electric motors and impeller in composite material, which guarantees a reduction of power consumption;
- New fans electric motor that do not require maintenance;
- Total modulating, capable to follow the increasing demand of Data Center;
- Improvement of the control software with advanced control logic;
- Single or double refrigerant circuit;
- Hinged frontal panels and lateral panels fully removable to facilitate the operations of extraordinary maintenance;

F-GAS DIRECTIVE

The units highlighted in this publication contain <HFC R410A [GWP₁₀₀ 2088]> fluorinated greenhouse gases.

MODEL IDENTIFICATION

Air conditioners for IT Cooling

model: i-NEXT DW O 047 M1 S E5L

i-NEXT	Series
DW	Unit type DW – direct expansion, water cooled
O	Air delivery O = over – upflow air delivery U = under – downflow air delivery
047	Model / Cooling capacity (kW) at nominal conditions
M1	Compressor type and number M = BLDC inverter compressor for R410A 1 = 1 BLDC inverter compressor 2 = 1 BLDC inverter compressor for refrigerant circuit 4 = 1 BLDC inverter + 1 ON/OFF compressor for refrigerant circuit
S	Refrigerant circuit S = single D = double
E5L	Size

STORING TEMPERATURE

If the machine is not installed on receipt and is stored for a long time, store it in a protected place, at temperatures ranging between -30°C and 50°C in absence of superficial condensation and direct sun light.

WORKING LIMITS

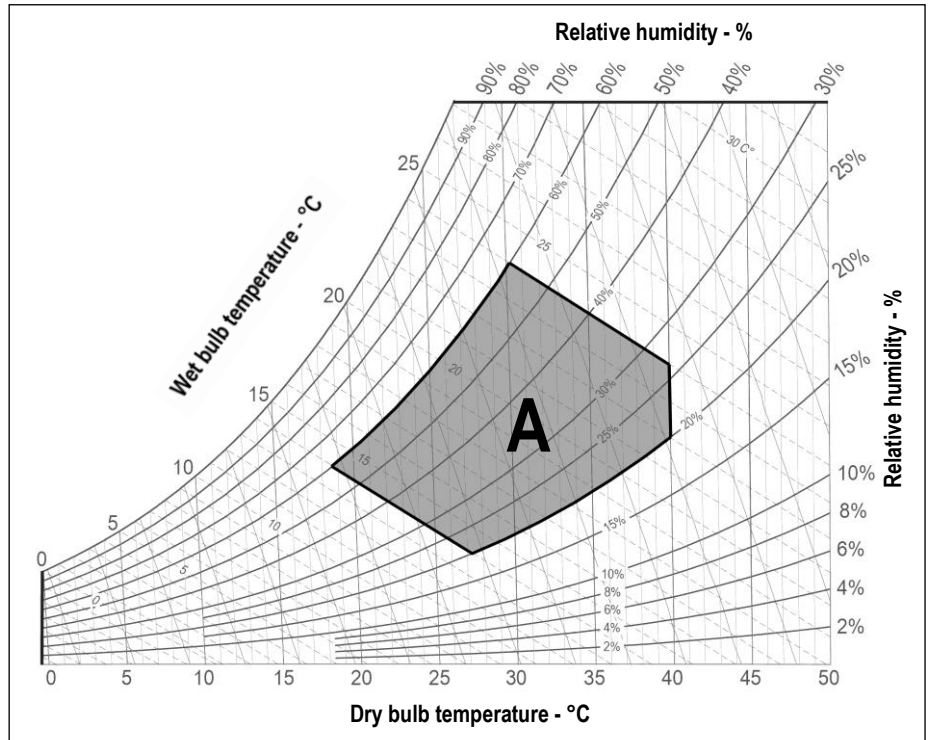

ROOM AIR CONDITIONS

Room air temperature:

- 14°C minimum temperature with wet bulb.
- 24°C maximum temperature with wet bulb.
- 18°C minimum temperature with dry bulb
- 40°C maximum temperature with dry bulb.

AREA "A". Machine operating envelope.

Room air humidity:

- 20%RH minimum relative humidity.
- 60%RH maximum relative humidity.

WATER COOLED CONDENSER

Inlet water temperature:

- 6-20°C Inlet water temperature range – the 2-way valve optional for condensing control is required.
- 20-50°C Inlet water temperature range – without necessarily using the 2-way valve optional for condensing control.

Outlet water temperature:

- 25-55°C Outlet water temperature range

Operating ΔT:

- 4-20°C Operating ΔT between water inlet / outlet

All the values are indicative. The working temperatures are influenced by a series of variables as:

- Working conditions;
- Thermal load;
- Set of the microprocessor control.

CIRCUITO IDRAULICO

- 10 Bar Maximum working pressure of the hydraulic circuit

POWER SUPPLY

- ± 10% Maximum tolerance of the supply voltage (V)
- ± 2% Maximum unbalancing of the phases.



MAIN COMPONENTS



FRAMEWORK

- Base in aluminium extrusion, painted with epoxy powders. Colour RAL 9005;
- Frame in aluminium profile, painted with epoxy powders. The inner frame is provided with seals for the panels. Colour RAL 9005;
- Panels in galvanized steel sheet with protective surfaces treatment in compliance with UNI ISO 9227/ASTMB117 and ISO 7253, and painted with epoxy powders. Colour RAL 7016 hammered;
- Panels insulated with polyurethane foam and seals to ensure air tight.
- Hinged front panels with quick release removal system.
- Total front access for routine maintenance.
- Removable lateral and back side panels.
- Air flow OVER version:
 - Air intake from the front through honeycomb type grille and air delivery from the top.
- Air flow UNDER version:
 - Air intake from the top and air delivery from the bottom.
- Compartment for electrical panel on unit front for direct access to control and regulation devices;

FILTER SECTION

- Washable air filters with COARSE 60% efficiency (according to ISO EN 16890), with cells in synthetic fibre and metallic frame.
- Air filters access:
 - OVER version
 - Frontal access for all machines
 - UNDER version
 - For machines size E1 - E2 – E3 frontal access
 - For machine size E4L – E5L – E7L – E8L – E9L access from upper side
- Differential pressure switch on the air side for clogged filters alarm signal.

BLDC INVERTER COMPRESSORS SECTION

Unit size E1:

- rotary BLDC inverter compressor for R410A refrigerant:

Unit size E2, E3, E4L, E5L, E7L, E8L:

- scroll BLDC inverter compressors with spiral profile optimized for R410A refrigerant:
 - S version, single refrigerant circuit:
 - single BLDC inverter compressor;
 - D version, double refrigerant circuit:
 - single BLDC inverter compressor for each refrigerant circuit;
- Synchronous brushless inverter driven motor.
- Inverter for modulating capacity control.
- Reactance for the reduction of electromagnetic noise and interference.

ONLY FOR UNIT SIZE E9L – DOUBLE REFRIGERANT CIRCUIT

- One BLDC inverter compressor + one on/off compressor for each refrigerant circuit.
- Characteristics of on/off compressor:
 - Scroll rotary compressors with spiral profile optimized for R410A refrigerant.
 - 2-pole 3-phase electric motor with direct on line starting.

FOR ALL COMPRESSORS:

- Crankcase heater for each compressor.
- Soundproof cap for each compressor.
- Rubber supports.

FAN SECTION

The fan section is contained within the machine and includes:

- Centrifugal fans with backward curved blades with wing profile, single suction and without scroll housings (Plug-fans), directly coupled to external rotor electric motor.
- Impeller in composite material exempt from rust formation.
- Brushless type synchronous EC motor with integrated electronic commutated system and continuous variation of the rotation speed. The motor rotation control is obtained with the EC system (Electronic Commutation) that manage the motor according to the signal coming from the microprocessor control.
- Fans control through ModBus. In case of failure, the control stops the interested fan indicating the type of fault. The machine with more than one fan is not stopped.
- Fan guard with rubber support (UNDER version)



COOLING SECTION

- Heat exchanger coil with internally corrugated copper tubes and high efficiency aluminium fins, specifically developed to provide high heat transfer and lower pressure drops.
- Frame in galvanized steel or peralluman.
- Condensate tray in peralluman with PVC flexible discharge pipe.
- Temperature sensors on air intake with control and regulation functions.
- Temperature sensors on air delivery with function of control and regulation.
- Under floor water alarm through sensor to be placed on the floor.

CONDENSING SECTION

- Copper brazed plate type with cover plates, plates and connections in AISI 316 stainless steel.
- 0÷10V proportional signal to manage the condensing control system

REFRIGERANT CIRCUIT

Components for each refrigerant circuit:

- Electronic expansion valve. The valve allows high performance and system efficiency thanks to a timely and accurate response to changes in temperature and pressure
- Sight glass.
- Filter dryer on liquid line.
- Pressure transducers with indication, control and protection functions, on low and high refrigerant pressure.
- High pressure safety switch with manual reset.
- Liquid receiver with accessories.
- Refrigerant circuit with copper tubing with anticondensate insulation of the suction line.
- R410A refrigerant charge and lubricant oil.

ELECTRICAL PANEL

In accordance with EN60204-1 norms, suitable for indoor installation, complete with:

- Main switch with door lock safety on frontal panel.
 - Magnetothermic switches for each compressor.
 - Magnetothermic switches for supply fans.
 - Contactors for each load. BLDC inverter compressors and supply fans equipped with EC electric motor don't require contactors.
 - Unit size E9L, D version, double refrigerant circuit:
 - Phases sequence control relay for the machine. The system checks that the phase sequence of the power supply is correct to prevent the opposite rotation of the three phase electric motors of the machine as compressor motors, fan motors. It is installed downstream the main switch with door lock safety and in case of wrong phase sequence prevents starting the machine;
 - Transformer for auxiliary circuit and microprocessor supply.
 - Terminals:
- OUTLETS**
- Voltage free deviating contact for General Alarm 1,2.
 - Voltage free contact for supply fans status.
 - Voltage free contact for smoke / fire sensor (the sensors are accessory)
- INLETS**
- External enabling.
- Power supply 400/3+N/50.

CONTROL SYSTEM

Microprocessor control system with graphic display for control and monitor of operating and alarms status. The system includes:

- Built-in clock for alarms date and time displaying and storing;
- Built-in memory for the storing of the intervened events (up to 200 events recorded);
- Predisposition for connectivity board housing (MBUS RS485/JBUS, MBUS RS232/JBUS for GSM modem, LON, BACnet for Ethernet (SNMP- TCP/IP), BACnet for MS/TP). The electronic cards are optional accessories;
- Main components hour-meter;
- Non-volatile "Flash" memory for data storage in case of power supply faulty;
- Menu with protection password;
- Demand Limit function (for machines with double refrigerant circuit only);
- LAN connection (max 10 units).

OPTIONAL ACCESSORIES

The descriptions of these additional components can be found in Chapter OPTIONAL ACCESSORIES.

- Double power supply with automatic change-over. Not compatible with “oversized electric heaters” and “oversized humidifier” optional accessories.
- Network analyser: multifunction utility for calculating and displaying the machine electrical measurements. Not compatible with “oversized electric heaters” and “oversized humidifier” optional accessories.
- Smoke sensor. Supplied in mounting kit.
- Fire sensor. Supplied in mounting kit.
- Condensate drain system including pump with activation float and 10 linear meters long discharge pipe. For all the machines the optional is supplied in mounting kit.
- Modulating steam humidifier with immersed electrodes with electronic control. The optional foresee the combined Temperature / Humidity sensor on return air.
- Dehumidification system. The optional foresee the combined Temperature / Humidity sensor on return air.
- 2-way motorized valve for condensing control with 0÷10 VDC control actuator and emergency manual control.
- Electric heating system consisting of aluminium armoured elements with integral fins.
- On/off type hot gas reheating system (only for machine with single refrigerant circuit). Not compatible with “hot water heating system”.
- Hot water heating system. Not compatible with “On/off type gas reheating system”.
- Unit floor stand with height adjusting rubber holders. It is not possible to match the unit floor stand with plenum installed under the machine.
- Double panels Euroclass A1.
- Washable air filter with ePM₁₀ 50% efficiency (according to ISO EN 16890). Not compatible with optional plenum with ePM_{2.5} 50%, ePM₁ 50%, ePM₁ 85% (according to ISO EN 16890) efficiency filters on air delivery.
- Non-return air damper driven by electric servomotor installed on the machine air delivery.
- Empty plenum. Available in Euroclass A1.
- Plenum with noise absorption partitions on air delivery. Not compatible with optional washable air filter with ePM₁₀ 50% efficiency.
- Plenum with noise absorption partitions on air return. Not compatible with optional washable air filter with ePM₁₀ 50% efficiency.
- Plenum with ePM_{2.5} 50%, ePM₁ 50%, ePM₁ 85% efficiency filters on air delivery. Not compatible with washable air filter with ePM₁₀ 50% efficiency.
- Air distribution plenum with double row adjustable grille on front side. Available in Euroclass A1.
- Air distribution plenum with double row adjustable grilles on three sides. Available in Euroclass A1.
- Air distribution plenum with double row adjustable grille on front side and noise absorption partitions.
- Plenum for direct free-cooling on air intake. The optional foresee the combined Temperature / Humidity sensor on machine air suction and the Temperature sensor for ambient air.
- Unit base noise insulation with special bottom panel for OVER version.
Restriction: Not compatible with blind frontal panel for OVER version.
- KIP LINK: Keyboard in your pocket. Allows to operate on the unit with smartphone or tablet.
- CLOUD PLATFORM: Web services based on cloud technology for remote monitoring and management.

OTHER ACCESSORIES

- Automatic system for the air pressure control in the under floor. The system controls the supply fans rotation speed in order to keep constant the air pressure in the under floor via a differential pressure transmitter connected to the microprocessor control.
- Solenoid valve on liquid line.
- Blind frontal panel for OVER version. The accessory allows the intake air from the bottom of the machine.
Restriction: Not compatible with unit base noise insulation with special bottom panel for OVER version.
- Additional underfloor water sensor kit.
- Phases sequence control relay for the machine. The system checks that the phase sequence of the power supply is correct to prevent the opposite rotation of the three phase electric motors of the machine as compressor motors, fan motors. The optional is installed in the electrical box downstream the main switch with door lock safety and in case of wrong phase sequence prevents starting the machine (standard for size E9);
- Combined Temperature / Humidity sensor on return air.
- Temperature sensor for outdoor installation.
- Combined Temperature / Humidity sensor for remote installation. The optional is added to the standard sensor on machine air suction.
- Microprocessor control accessories:
 - Remote terminal.
 - Serial card MBUS RS485/JBUS.
 - Serial card MBUS RS232/JBUS for GSM modem.
 - Serial card LON.
 - Serial card BACnet for Ethernet – SNMP – TCP/IP.
 - Serial card BACnet for MS/TP.
 - Temporary microprocessor power supply. The system guarantees the microprocessor power supply for a few minutes, in case of supply voltage failure.
 - Voltage free contact for on/off compressor status (only for size E9).
 - Analogue set point compensation according to an external analogue signal at Customer care.
The microprocessor control, through the additional module “expansion card”, can manage a compensation signal of the return air setpoint by analogue input (0...1V; 0...5V; 0,5...4,5V; 4...20mA; 0...20mA). The compensation curve allows to assign a temperature setpoint offset respectively to the minimum and maximum signal managed by the input.

WARNING

The Manufacturer reserves the right to accept the matching of the optional installed on the machine.



TECHNICAL DATA

MODEL	012 M1 S					018 M1 S					
SIZE	E1					E2					
VERSION (1)	U / O					U / O					
COOLING CAPACITY (2)	100%	80%	60%	40%	30%	100%	80%	60%	40%	30%	
Total	kW	11	8,8	6,6	4,4	3,37	23	18,4	13,8	9,2	6,88
Sensible	kW	11	8,54	6,59	4,4	3,36	20,8	16,8	12,7	8,61	6,87
SHR (3)		1	0,97	1	1	1	0,9	0,91	0,92	0,93	1
Total power input (Comp. + Fans)	kW	2,37	1,54	0,99	0,58	0,4	5,82	4,09	2,72	1,58	1,17
Condenser water flow rate	m³/h	2,26	--	--	--	--	4,89	--	--	--	--
Condenser pressure drop	kPa	27,9	--	--	--	--	45,5	--	--	--	--
"EC" SUPPLY FANS	n.	1					1				
Air flow	m³/h	2800	2425	2050	1675	1500	4100	3358	2616	1874	1500
Nominal external static pressure	Pa	20	20	20	20	20	20	20	20	20	20
Maximum external static pressure	Pa	83	--	--	--	--	314	--	--	--	--
Power input (4)	kW	0,28	0,18	0,12	0,09	0,07	0,52	0,35	0,21	0,12	0,08
COMPRESSORS		Rotary					Scroll				
BLDC compressors	n.	1					1				
On/Off compressors	n.	0					0				
Cooling Capacity Control		Modulating					Modulating				
Compressors power input	kW	2,34	1,36	0,87	0,49	0,33	5,3	3,74	2,51	1,46	1,09
WATER COOLED CONDENSER	n.	1					1				
Water volume	l	1,1					1,1				
Max water flow rate	m³/h	5,7					6,4				
AIR FILTERS	n.	1					1				
Filtering surface	m²	0,6					0,8				
Efficiency (ISO EN 16890)	COARSE	60%					60%				
REFRIGERANT	n.	1					1				
Refrigerant circuit x Refrigerant charge (5)	n x kg	1x3,2					1x3,8				
HFC R410A - F Gas - CO ₂ equivalent	t	6,7					7,9				
POWER SUPPLY	V/Ph/Hz	400/3+N/50					400/3+N/50				
ENERGY EFFICIENCY INDEXES (2)											
EER - Energy Efficiency Ratio	kW/kW	4,64	5,71	6,67	7,59	8,42	3,95	4,5	5,07	5,82	5,88
DIMENSIONS											
Length	mm	650					785				
Width	mm	675					675				
Height	mm	1925					1925				
NET WEIGHT Over	kg	230					280				
NET WEIGHT Under	kg	240					290				
CONNECTIONS ISO 228/1-G											
Condenser water inlet/outlet	M Ø	1"					1"				
HYDRAULIC CONNECTIONS											
CONDENSATE DISCHARGE											
Rubber pipe – internal diameter	Ø mm	19					19				

THE COOLING CAPACITY DOES NOT CONSIDER THE SUPPLY FAN MOTOR THERMAL LOAD

1. U = Under, downflow / O = Over, upflow
2. Gross value. Characteristics referred to entering air at 26°C-40%UR; water to the condenser 30-35°C; ESP=20Pa.
3. SHR = Sensible cooling capacity / Total cooling capacity.
4. Corresponding to the nominal external static pressure.
5. **The air conditioner is supplied with R410A refrigerant charge.** Unit refrigerant charge optional excluded. For air conditioners with double refrigerant circuit is indicated the number of circuits x the charge of a single circuit.

The units highlighted in this publication contain <HFC R410A [GWP₁₀₀ 2088]> fluorinated greenhouse gas.

NOTE:

Below 30% of cooling capacity, the inverter compressor enters the "cycling" area in which the compressor operates with ON / OFF cycles below the minimum modulation frequency (operation only for short periods).

SELECT THE UNIT IN THE MODULATION FIELD



TECHNICAL DATA

MODEL	022 M1 S						030 M1 S					
SIZE	E3						E4L					
VERSION (1)												
COOLING CAPACITY (2)	100%	80%	60%	40%	30%		100%	80%	60%	40%	30%	
Total	kW	25,4	20,3	15,2	10,2	7,32	41,3	33	24,8	16,5	12,3	
Sensible	kW	24,8	19,5	14,9	9,61	7,32	41,3	32,9	24,8	16,5	12,3	
SHR (3)		0,97	0,96	0,98	0,94	1	1	1	1	1	1	
Total power input (Comp. + Fans)	kW	5,89	4,2	2,69	1,58	1,12	10	6,9	4,48	2,6	1,81	
Condenser water flow rate	m ³ /h	5,29	--	--	--	--	8,56	--	--	--	--	
Condenser pressure drop	kPa	33,2	--	--	--	--	27,5	--	--	--	--	
"EC" SUPPLY FANS	n.	1						1				
Air flow	m ³ /h	5500	4432	3365	2297	1700	10000	7978	5955	3933	2900	
Nominal external static pressure	Pa	20	20	20	20	20	20	20	20	20	20	
Maximum external static pressure	Pa	860	--	--	--	--	219	--	--	--	--	
Power input (4)	kW	0,72	0,39	0,23	0,12	0,07	1,95	1,06	0,47	0,19	0,11	
COMPRESSORS		Scroll						Scroll				
BLDC compressors	n.	1						1				
On/Off compressors	n.	0						0				
Cooling Capacity Control		Modulating						Modulating				
Compressors power input	kW	5,17	3,82	2,46	1,45	1,05	8,09	5,84	4,01	2,41	1,7	
WATER COOLED CONDENSER	n.	1						1				
Water volume	l	1,9						3,7				
Max water flow rate	m ³ /h	6,9						11,2				
AIR FILTERS	n.	2						2				
Filtering surface	m ²	1,2						2,1				
Efficiency (ISO EN 16890)	COARSE	60%						60%				
REFRIGERANT	n.	1						1				
Refrigerant circuit x Refrigerant charge (5)	n x kg	1x4,6						1x6,8				
HFC R410A - F Gas - CO ₂ equivalent	t	9,6						14,2				
POWER SUPPLY	V/Ph/Hz	400/3+N/50						400/3+N/50				
ENERGY EFFICIENCY INDEXES (2)												
EER - Energy Efficiency Ratio	kW/kW	4,31	4,83	5,65	6,46	6,54	4,13	4,78	5,54	6,35	6,8	
DIMENSIONS												
Length	mm	1085						1630				
Width	mm	775						930				
Height	mm	1925						1980				
NET WEIGHT Over	kg	325						480				
NET WEIGHT Under	kg	345						490				
CONNECTIONS ISO 228/1-G												
Condenser water inlet/outlet	M Ø	1 1/4"						1 1/2"				
HYDRAULIC CONNECTIONS												
CONDENSATE DISCHARGE												
Rubber pipe – internal diameter	Ø mm	19						19				

THE COOLING CAPACITY DOES NOT CONSIDER THE SUPPLY FAN MOTOR THERMAL LOAD

1. U = Under, downflow / O = Over, upflow
2. Gross value. Characteristics referred to entering air at 26°C-40%UR; water to the condenser 30-35°C; ESP=20Pa.
3. SHR = Sensible cooling capacity / Total cooling capacity.
4. Corresponding to the nominal external static pressure.
5. **The air conditioner is supplied with R410A refrigerant charge.** Unit refrigerant charge optional excluded. For air conditioners with double refrigerant circuit is indicated the number of circuits x the charge of a single circuit.

The units highlighted in this publication contain <HFC R410A [GWP₁₀₀ 2088]> fluorinated greenhouse gas.

NOTE:

Below 30% of cooling capacity, the inverter compressor enters the "cycling" area in which the compressor operates with ON / OFF cycles below the minimum modulation frequency (operation only for short periods).

SELECT THE UNIT IN THE MODULATION FIELD



TECHNICAL DATA

MODEL	047 M1 S						042 M2 D					
SIZE	E5L						E5L					
VERSION (1)	U / O						U / O					
COOLING CAPACITY (2)	100%	80%	60%	40%	30%		100%	80%	60%	40%	30%	
Total	kW	56,2	45	33,7	22,5	17,9	51,8	41,4	31,1	20,7	15,9	
Sensible	kW	54,3	45	33,7	22,5	17,9	51,7	41,4	31,1	20,7	15,9	
SHR (3)		0,97	1	1	1	1	1	1	1	1	1	
Total power input (Comp. + Fans)	kW	14,1	9,47	5,94	3,36	2,43	12,7	8,72	5,47	3,12	2,3	
Condenser water flow rate	m ³ /h	11,77	--	--	--	--	10,76	--	--	--	--	
Condenser pressure drop	kPa	50,7	--	--	--	--	23,1	--	--	--	--	
"EC" SUPPLY FANS	n.	1						1				
Air flow	m ³ /h	12000	9858	7715	5573	4700	12000	9893	7787	5680	4700	
Nominal external static pressure	Pa	20	20	20	20	20	20	20	20	20	20	
Maximum external static pressure	Pa	217	--	--	--	--	217	--	--	--	--	
Power input (4)	kW	2,27	1,4	0,76	0,34	0,23	2,27	1,4	0,76	0,35	0,23	
COMPRESSORS		Scroll						Scroll				
BLDC compressors	n.	1						2				
On/Off compressors	n.	0						0				
Cooling Capacity Control		Modulating						Modulating				
Compressors power input	kW	11,9	8,07	5,18	3,02	2,2	10,5	7,31	4,7	2,77	2,07	
WATER COOLED CONDENSER	n.	1						1				
Water volume	l	3,7						3,4				
Max water flow rate	m ³ /h	15,4						14				
AIR FILTERS	n.	3						3				
Filtering surface	m ²	2,6						2,59				
Efficiency (ISO EN 16890)	COARSE	60%						60%				
REFRIGERANT	n.	1						2				
Refrigerant circuit x Refrigerant charge (5)	n x kg	1x9,9						2x4,7				
HFC R410A - F Gas - CO ₂ equivalent	t	20,7						19,6				
POWER SUPPLY	V/Ph/Hz	400/3+N/50						400/3+N/50				
ENERGY EFFICIENCY INDEXES (2)												
EER - Energy Efficiency Ratio	kW/kW	3,99	4,75	5,67	6,7	7,37	4,08	4,75	5,69	6,63	6,91	
DIMENSIONS												
Length	mm	1955						1955				
Width	mm	930						930				
Height	mm	1980						1980				
NET WEIGHT Over	kg	580						610				
NET WEIGHT Under	kg	590						620				
CONNECTIONS ISO 228/1-G												
Condenser water inlet/outlet	M Ø	2"						2"				
HYDRAULIC CONNECTIONS												
CONDENSATE DISCHARGE												
Rubber pipe – internal diameter	Ø mm	19						19				

THE COOLING CAPACITY DOES NOT CONSIDER THE SUPPLY FAN MOTOR THERMAL LOAD

1. U = Under, downflow / O = Over, upflow
2. Gross value. Characteristics referred to entering air at 26°C-40%UR; water to the condenser 30-35°C; ESP=20Pa.
3. SHR = Sensible cooling capacity / Total cooling capacity.
4. Corresponding to the nominal external static pressure.
5. **The air conditioner is supplied with R410A refrigerant charge.** Unit refrigerant charge optional excluded. For air conditioners with double refrigerant circuit is indicated the number of circuits x the charge of a single circuit.

The units highlighted in this publication contain <HFC R410A [GWP₁₀₀ 2088]> fluorinated greenhouse gas.

NOTE:

Below 30% of cooling capacity, the inverter compressor enters the "cycling" area in which the compressor operates with ON / OFF cycles below the minimum modulation frequency (operation only for short periods).

SELECT THE UNIT IN THE MODULATION FIELD



TECHNICAL DATA

MODEL	068 M2 D						094 M2 D					
SIZE	E7L						E8L					
VERSION (1)	U / O						U / O					
COOLING CAPACITY (2)	100%	80%	60%	40%	30%		100%	80%	60%	40%	30%	
Total	kW	82,5	66	49,5	33	24,7	110	88	66	44	34,4	
Sensible	kW	82,5	65,9	49,2	32,9	24,7	103	83,7	62,5	42,1	34,4	
SHR (3)		1	1	0,99	1	1	0,93	0,95	0,94	0,95	1	
Total power input (Comp. + Fans)	kW	19,8	13,6	8,8	5,16	3,63	27,4	18,4	11,6	6,63	4,75	
Condenser water flow rate	m ³ /h	17,13	--	--	--	--	23,11	--	--	--	--	
Condenser pressure drop	kPa	28,9	--	--	--	--	33,1	--	--	--	--	
"EC" SUPPLY FANS	n.	2						2				
Air flow	m ³ /h	20000	15946	11893	7839	5800	22000	17926	13852	9778	8000	
Nominal external static pressure	Pa	20	20	20	20	20	20	20	20	20	20	
Maximum external static pressure	Pa	474	--	--	--	--	388	--	--	--	--	
Power input (4)	kW	3,37	1,87	0,9	0,34	0,23	3,72	2,22	1,08	0,5	0,35	
COMPRESSORS		Scroll						Scroll				
BLDC compressors	n.	2						2				
On/Off compressors	n.	0						0				
Cooling Capacity Control		Modulating						Modulating				
Compressors power input	kW	16,4	11,7	7,91	4,83	3,4	23,7	16,2	10,5	6,12	4,4	
WATER COOLED CONDENSER	n.	1						1				
Water volume	l	5,6						7,4				
Max water flow rate	m ³ /h	22,4						30				
AIR FILTERS	n.	4						5				
Filtering surface	m ²	3,83						4,47				
Efficiency (ISO EN 16890)	COARSE	60%						60%				
REFRIGERANT	n.	2						2				
Refrigerant circuit x Refrigerant charge (5)	n x kg	2x6,9						2x10,1				
HFC R410A - F Gas - CO ₂ equivalent	t	28,8						41,2				
POWER SUPPLY	V/Ph/Hz	400/3+N/50						400/3+N/50				
ENERGY EFFICIENCY INDEXES (2)												
EER - Energy Efficiency Ratio	kW/kW	4,17	4,85	5,62	6,4	6,8	4,01	4,78	5,69	6,64	7,24	
DIMENSIONS												
Length	mm	2499						2899				
Width	mm	930						930				
Height	mm	1980						1980				
NET WEIGHT Over	kg	730						900				
NET WEIGHT Under	kg	785						960				
CONNECTIONS ISO 228/1-G												
Condenser water inlet/outlet	M Ø	2 1/2"						2 1/2"				
HYDRAULIC CONNECTIONS												
CONDENSATE DISCHARGE												
Rubber pipe – internal diameter	Ø mm	19						19				

THE COOLING CAPACITY DOES NOT CONSIDER THE SUPPLY FAN MOTOR THERMAL LOAD

1. U = Under, downflow / O = Over, upflow
2. Gross value. Characteristics referred to entering air at 26°C-40%UR; water to the condenser 30-35°C; ESP=20Pa.
3. SHR = Sensible cooling capacity / Total cooling capacity.
4. Corresponding to the nominal external static pressure.
5. **The air conditioner is supplied with R410A refrigerant charge.** Unit refrigerant charge optional excluded. For air conditioners with double refrigerant circuit is indicated the number of circuits x the charge of a single circuit.

The units highlighted in this publication contain <HFC R410A [GWP₁₀₀ 2088]> fluorinated greenhouse gas.

NOTE:

Below 30% of cooling capacity, the inverter compressor enters the "cycling" area in which the compressor operates with ON / OFF cycles below the minimum modulation frequency (operation only for short periods).

SELECT THE UNIT IN THE MODULATION FIELD



TECHNICAL DATA

MODEL	120 M4 D						150 M4 D					
SIZE	E9L						E9L					
VERSION (1)	U						U					
COOLING CAPACITY (2)	100%	80%	60%	40%	30%		100%	80%	60%	40%	30%	
Total	kW	116	92,8	69,6	46,4	31,9	140	112	84	56	32,8	
Sensible	kW	116	92,7	69,5	46,4	31,9	140	112	84	56	32,8	
SHR (3)		1	1	1	1	1	1	1	1	1	1	
Total power input (Comp. + Fans)	kW	28,2	19,2	12,4	7,84	4,49	37,8	25	16	9,33	4,69	
Condenser water flow rate	m ³ /h	24,26	--	--	--	--	29,8	--	--	--	--	
Condenser pressure drop	kPa	32,3	--	--	--	--	49,8	--	--	--	--	
"EC" SUPPLY FANS	n.	2						2				
Air flow	m ³ /h	28000	22621	17241	11862	8500	32000	25862	19724	13586	8500	
Nominal external static pressure	Pa	20	20	20	20	20	20	20	20	20	20	
Maximum external static pressure	Pa	572	--	--	--	--	362	--	--	--	--	
Power input (4)	kW	4,2	2,46	1,29	0,6	0,33	5,99	3,46	1,77	0,78	0,33	
COMPRESSORS		Scroll						Scroll				
BLDC compressors	n.	2						2				
On/Off compressors	n.	0						0				
Cooling Capacity Control		Modulating						Modulating				
Compressors power input	kW	24	16,7	11,1	7,24	4,16	31,8	21,5	14,2	8,56	4,36	
WATER COOLED CONDENSER	n.	1						1				
Water volume	l	12						12				
Max water flow rate	m ³ /h	42						42				
AIR FILTERS	n.	6						6				
Filtering surface	m ²	5,24						5,24				
Efficiency (ISO EN 16890)	COARSE	60%						60%				
REFRIGERANT	n.	2						2				
Refrigerant circuit x Refrigerant charge (5)	n x kg	2x10,8						2x10,8				
HFC R410A - F Gas - CO ₂ equivalent	t	45,1						45,1				
POWER SUPPLY	V/Ph/Hz	400/3+N/50						400/3+N/50				
ENERGY EFFICIENCY INDEXES (2)												
EER - Energy Efficiency Ratio	kW/kW	4,11	4,83	5,61	5,92	7,1	3,7	4,48	5,25	6	6,99	
DIMENSIONS												
Length	mm	3299						3299				
Width	mm	930						930				
Height	mm	1980						1980				
NET WEIGHT Over	kg	--						--				
NET WEIGHT Under	kg	1100						1125				
CONNECTIONS ISO 228/1-G												
Condenser water inlet/outlet	M Ø	3"						3"				
HYDRAULIC CONNECTIONS												
CONDENSATE DISCHARGE												
Rubber pipe – internal diameter	Ø mm	19						19				

THE COOLING CAPACITY DOES NOT CONSIDER THE SUPPLY FAN MOTOR THERMAL LOAD

1. U = Under, downflow / O = Over, upflow
2. Gross value. Characteristics referred to entering air at 26°C-40%UR; water to the condenser 30-35°C; ESP=20Pa.
3. SHR = Sensible cooling capacity / Total cooling capacity.
4. Corresponding to the nominal external static pressure.
5. **The air conditioner is supplied with R410A refrigerant charge.** Unit refrigerant charge optional excluded. For air conditioners with double refrigerant circuit is indicated the number of circuits x the charge of a single circuit.

The units highlighted in this publication contain <HFC R410A [GWP₁₀₀ 2088]> fluorinated greenhouse gas.

NOTE:

Below 30% of cooling capacity, the inverter compressor enters the "cycling" area in which the compressor operates with ON / OFF cycles below the minimum modulation frequency (operation only for short periods).

SELECT THE UNIT IN THE MODULATION FIELD



REFRIGERANT CIRCUIT

Below refrigerant diagrams for version with single or double refrigerant circuit. The diagrams refer to the standard configuration, without optional.

UNDER - SINGLE REFRIGERANT CIRCUIT

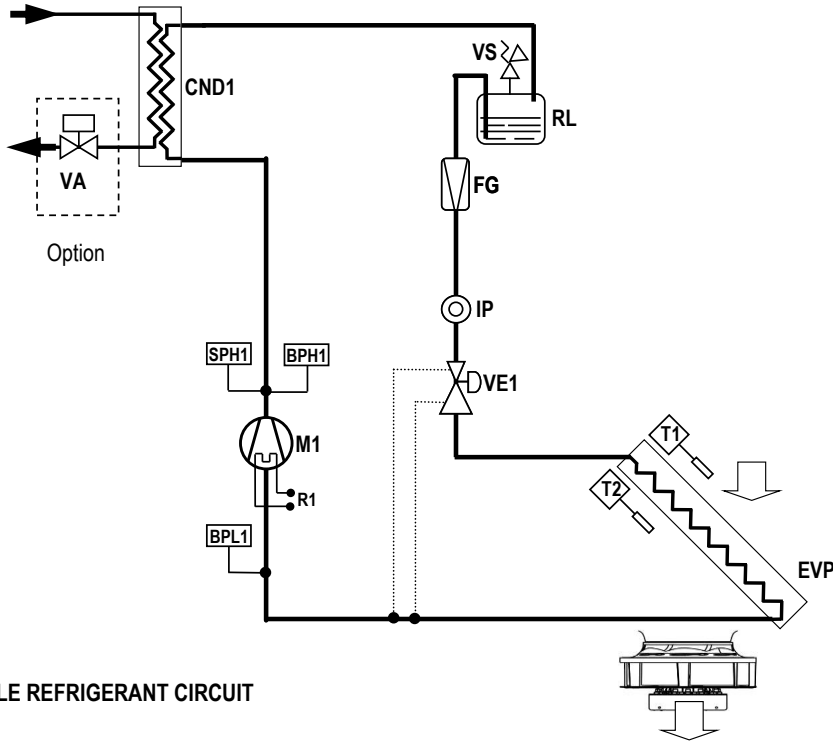

OVER - SINGLE REFRIGERANT CIRCUIT

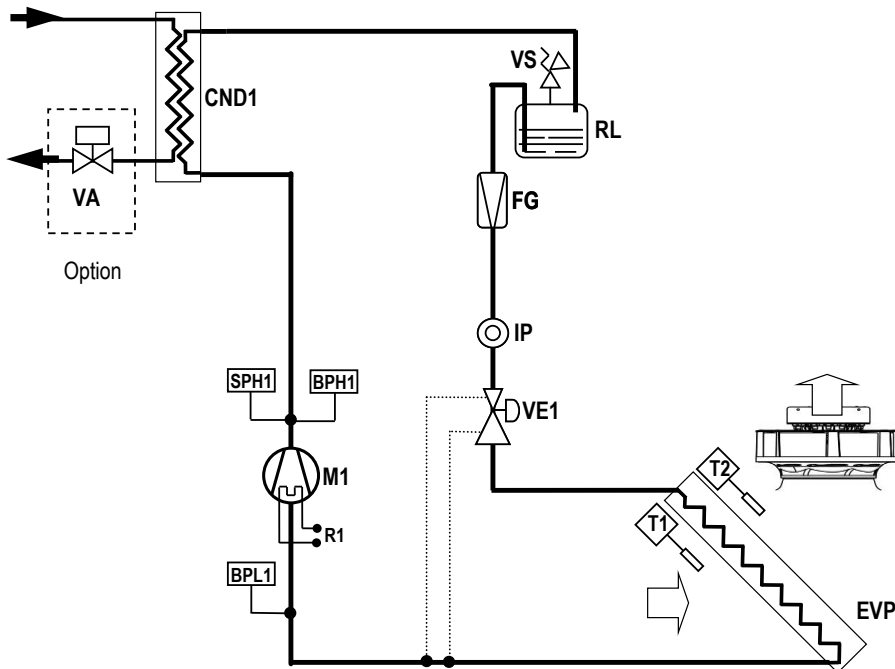

LEGENDA

M1	BLDC inverter compressor	BPL	Low pressure transducer.	IP	Sight glass.
R1	Crankcase heater	SPH	High pressure switch	VE	Expansion valve.
CND	Condenser.	VS	Safety valve.	T	Temperature probes.
EVP	Evaporator.	FG	Refrigerant filter.	RL	Liquid receiver
BPH	High pressure transducer.			VA	Motorized valve for condensing control (option)



UNDER - DOUBLE REFRIGERANT CIRCUIT

SIZE E9

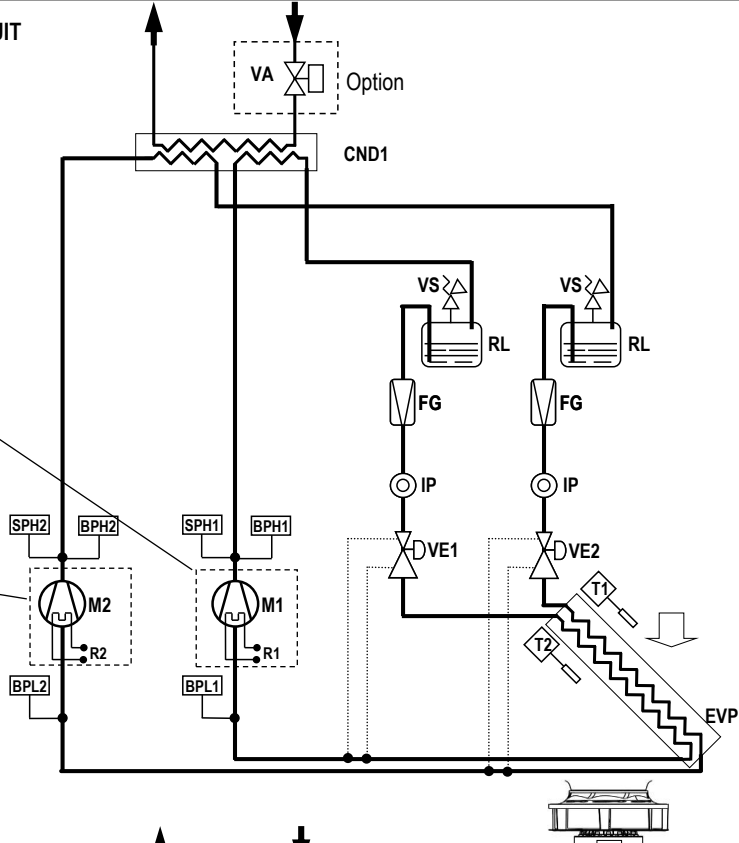
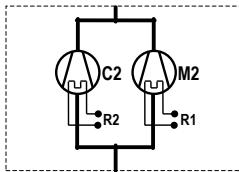
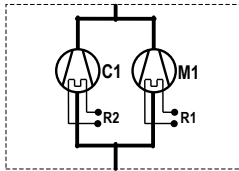

OVER - DOUBLE REFRIGERANT CIRCUIT

SIZE E9

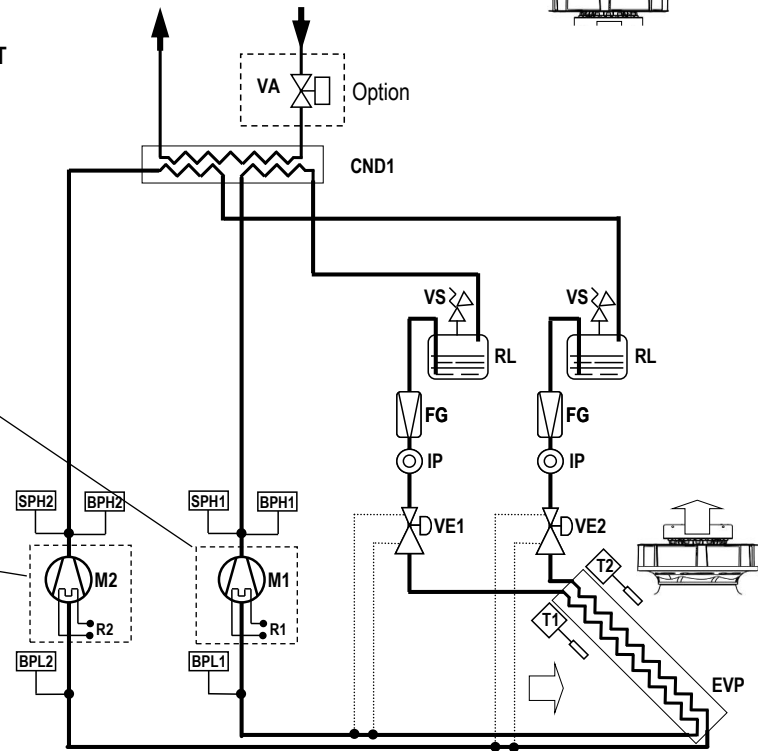
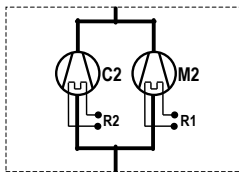
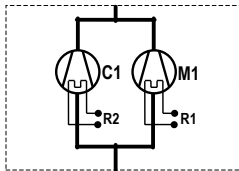

LEGENDA

- M1...2 BLDC inverter compressor 1, 2
- C1...2 on/off compressor 1, 2
- R1...2 Crankcase heater 1, 2
- CND Condenser.
- EVP Evaporator.
- BPH High pressure transducer.

- BPL Low pressure transducer.
- SPH High pressure switch
- VS Safety valve.
- FG Refrigerant filter.

- IP Sight glass.
- VE Expansion valve.
- T Temperature probes.
- RL Liquid receiver
- VA Motorized valve for condensing control



WATER QUALITY

For a correct and optimal functioning of the hydraulic circuits (condensing/free-cooling water), a water quality must be guaranteed as indicated in the table below.

The values shown in the table must be guaranteed during the entire life cycle of the machine.

	Description	Symbol	Range
1	Hydrogen Ions	pH	7.5 ÷ 9
2	Presence of calcium (Ca) and magnesium (Mg)	Hardness	4 ÷ 8.5 °D
3	Chlorine ions	Cl ⁻	< 150 ppm
4	Iron Ions	Fe ³⁺	< 0.5 ppm
5	Manganese Ions	Mn ²⁺	< 0.05 ppm
6	Carbon dioxide	CO ₂	< 10 ppm
7	Hydrogen sulphide	H ₂ S	< 50 ppb
8	Oxygen	O ₂	< 0.1 ppm
9	Chlorine	Cl ₂	< 0.5 ppm
10	Ammonia	NH ₃	< 0.5 ppm
11	Ratio between carbonates and sulphates	HCO ₃ ⁻ /SO ₄ ²⁻	> 1
12	Sulphate ions	SO ₄ ⁻	< 100 ppm
13	Phosphate ions	PO ₄ ³⁻	< 2.0 ppm

where: $1/1.78^{\circ}D = 1^{\circ}Fr$ with $1^{\circ}Fr = 10 \text{ gr CaCO}_3 / \text{m}^3$

ppm = parts for millions

ppb = part for billion

Explanatory notes:

- ref.1: A greater concentration of hydrogen ions (pH) than 9 implies a high risk of deposits, whereas a lower pH than 7 implies a high risk of corrosion.
- ref.2: The hardness measures the amount of Ca and Mg carbonate dissolved in the water with a temperature lower than 100°C (temporary hardness). A high hardness implies a high risk of deposits.
- ref.3: The concentration of chloride ions with higher values than those indicated causes corrosion.
- ref. 4 - 5 - 8: The presence of iron and manganese ions and oxygen leads to corrosion.
- ref.6 - 7: Carbon dioxide and hydrogen sulphide are impurities that promote corrosion.
- ref.9: Usually in water from the waterworks it is a value of between 0.2 and 0.3 ppm. High values cause corrosion.
- ref.10: The presence of ammonia reinforces the oxidising power of oxygen
- ref.11: Below the value shown in the table, there is a risk of corrosion due to the trigger of galvanic currents between copper and other less noble metals.
- ref.12: The presence of sulphates ions triggers corrosion phenomenon.
- ref.13: The presence of phosphates ions triggers corrosion phenomenon.

It is necessary to carry out periodic checks, with withdrawals at different points of the hydraulic system.

During the first year of operation, checks are recommended every 4 months which can be reduced every 6 months starting from the second year of operation.

WARNING:

It is necessary that, in the presence of dirty and / or aggressive waters, an intermediate heat exchanger is installed upstream of the heat exchangers.

ACOUSTIC DATA

Acoustic data of the standard machine at full load working conditions.

WARNING:

In a closed room the noise produced by a sound source reaches the listener in two different ways:

- Directly
- Reflected from the surrounding walls, floor, ceiling, from furniture.

With the same sound source, the noise produced in a closed room is greater than that produced outdoors. In fact, the sound pressure level generated by the source, must be added to the one reflected from the room. Also, the shape of the room affects the sound.

MODEL		012 M1 S	018 M1 S	022 M1 S	030 M1 S	047 M1 S
SIZE		E1	E2	E3	E4L	E5L
COOLING CAPACITY		100%	100%	100%	100%	100%
SOUND LEVEL ISO 3744 (1)						
On air delivery Under	dB(A)	64,7	71,4	69,6	81,1	81,5
On air intake Under	dB(A)	55,9	57,1	55,6	66,9	68,9
On front side Under	dB(A)	47	48	46	57	59
On air delivery Over	dB(A)	64,7	71,4	69,6	81,1	81,5
On air intake Over (2)	dB(A)	53	47	49	58	64
On front side Over (3)	dB(A)	46,2	40,2	42,8	53,4	59,4

MODEL		042 M2 D	068 M2 D	094 M2 D	120 M4 D	150 M4 D
SIZE		E5L	E7L	E8L	E9L	E9L
COOLING CAPACITY		100%	100%	100%	100%	100%
SOUND LEVEL ISO 3744 (1)						
On air delivery Under	dB(A)	81,5	80,1	82,5	83,4	83,4
On air intake Under	dB(A)	68,9	67,5	69,9	70,9	70,9
On front side Under	dB(A)	59	58	60	62	62
On air delivery Over	dB(A)	81,5	80,1	82,5	--	--
On air intake Over (2)	dB(A)	64	62	65	--	--
On front side Over (3)	dB(A)	59,4	58,1	60,4	--	--

1. Noise pressure level at 1 meter in free field – ISO 3744
2. Air intake from the front
3. Air intake from the bottom

ELECTRICAL DATA

MODEL		012 M1 S	018 M1 S	022 M1 S	030 M1 S	047 M1 S
SIZE		E1	E2	E3	E4L	E5L
VERSION (1)		U / O	U / O	U / O	U / O	U / O
Power supply	V/ph/Hz	400/3+N/50	400/3+N/50	400/3+N/50	400/3+N/50	400/3+N/50
Maximum current input (FLA)	A	15,3	19,7	22,2	29,2	36,4

MODEL		042 M2 D	068 M2 D	094 M2 D	120 M4 D	150 M4 D
SIZE		E5L	E7L	E8L	E9L	E9L
VERSION (1)		U / O	U / O	U / O	U	U
Power supply	V/ph/Hz	400/3+N/50	400/3+N/50	400/3+N/50	400/3+N/50	400/3+N/50
Maximum current input (FLA)	A	40,4	58,9	72,9	168,0	196,0

1. U = Under, downflow / O = Over, upflow

WARNING:

The electric data indicated refer only to the indoor unit.

Optional accessory electric data are included within the dedicated chapters and must be added.

Please refer to ELCA WORLD selection program to calculate the electrical data of the air conditioner according to the requested optional accessories.







MICROPROCESSOR CONTROL SYSTEM

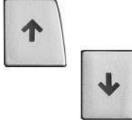

The microprocessor control system is equipped with 6 keys terminal and back lighted graphic display on which all information in different languages or easily identifiable symbols are displayed. The system disposes of a “flash” memory that preserves the information even in absence of power supply. Part of memory is dedicated to the registration of intervened events - up to 200 events.

KEYBOARD FUNCTIONS

	ALARM	Alarm, Back-red light active – alarm presence, push to have alarm description. If more than one alarm(s), the others can be scrolled by Key UP / DOWN
	PRG	Menu list, scrolled by key UP/DOWN: Unit; Set-point; In/Out; Clock; History; User; Service; Factory. Use the ENTER key to execute the mode.
	ESC	Home. Used to come back to the previous menu level or to the main screen.
	UP DOWN	Used to change the pages and values of sets. When display is in main screen (HOME), pressing one of them (UP/DOWN) will display the synoptic of the main controls.
	ENTER	Moving the cursor on adjustable Program(s) fields, to confirm the changes, press the key (ENTER) to get out of the fields.

CONNECTIVITY

Through the optional serial port, the microprocessor control enables communication with the modern buildings BMS systems with the following protocols:

- MBUS/JBUS (RS485) serial card;
- MBUS/JBUS (RS232) for GSM modem serial card;
- LON Works serial card;
- BACnet per Ethernet – SNMP – TCP/IP serial card;
- BACnet per MS/TP serial card;

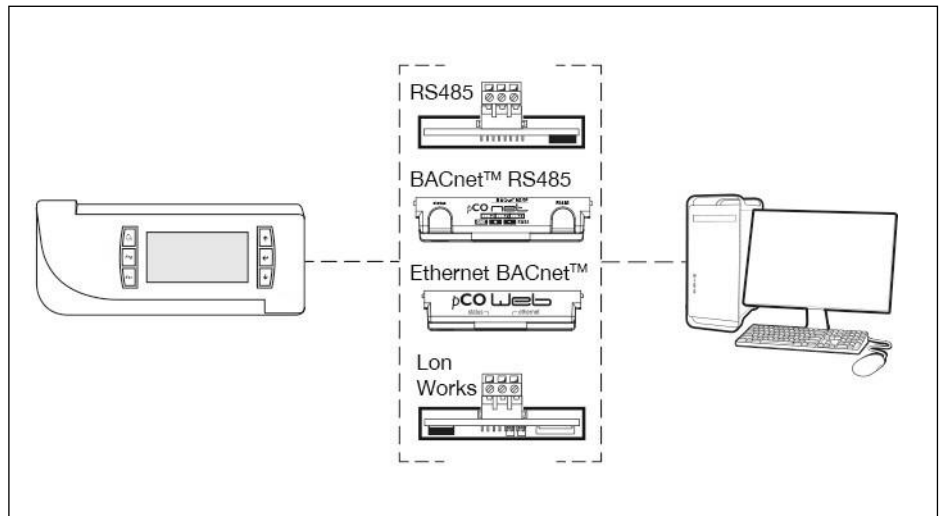

PASSWORD

- Level 1: On request of the End User. Allowing to reach USER menu
- Level 2: Asks to Service: Allowing to reach SERVICE menu
- Level 3: Asks to Service: Allowing to reach FACTORY menu

No passwords request to enter: UNIT, SETPOINT, IN/OUT, CLOCK, HISTORY menu

LAN NETWORK

The LAN is part of the control software and it is possible to connect up to 10 units.
 This type of connection allows to control the units in coherent way, moreover the units can be controlled and managed from a shared remote terminal.
 Electrical connections are on electrical panel connecting terminals.

LAN ADDRESS LIST

Unit #	1	2	3	4	5	6	7	8	9	10	Remote Terminal
Mother board address	1	2	3	4	5	6	7	8	9	10	--
Terminal address	11	12	13	14	15	16	17	18	19	20	32

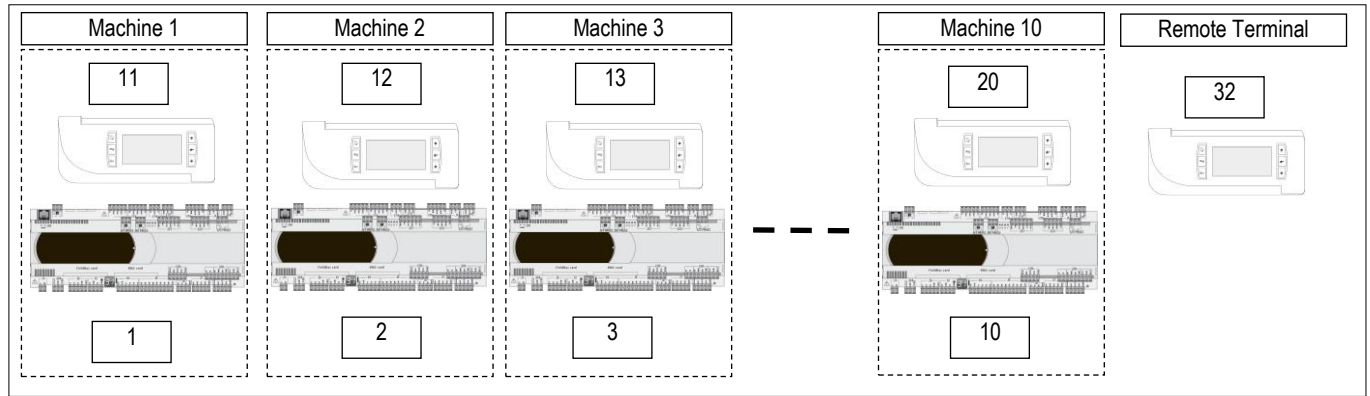

The unit connection to the local network (LAN) allows to perform the following functions:

- Balancing the operating hours among the different units by rotating the reserve units (Stand-by)
- Turning on the reserve units in case other units should turn off due to an alarm, maintenance or power feed interruption
- Turning on reserve units to offset the excessive thermal load
- Checking up to 10 units with a single user terminal (shared user terminal)

DEMAND LIMIT

Demand Limit function is part of the control software for machines with double refrigerant circuit. It allows to limit the absorbed current of the machine.
 The function must be activated and configurated. A digital inlet on electrical panel connecting terminals allows the remote enabling of the function with an external signal.
 The software allows to select the resources to disable (compressors, electric heaters,...).

POSSIBLE AIR INTAKE FOR OVER VERSIONS

OVER VERSION - AIR INTAKE FROM THE BOTTOM

Thanks to the particular basement design, it is possible to have the intake from the bottom side. The air flow is equal to the nominal.

With this solution, it is necessary to foresee the optional blind frontal panels

OVER VERSION - AIR INTAKE FROM THE BACK SIDE

(Sizes E4L, E5L, E6L, E7L, E8L, E9L excluded)

It is possible to have the unit air intake from the back side.

Due to the limited size of the air intake, the air flow is limited to the 20% of the nominal one.

The air intake has to be made by Customer during installation.

In case the air intake is used for fresh air, it is necessary the temperature / humidity probe reposition in front of the heat exchanger, to allow for optimum reading of the values of temperature / humidity.

The electric cable of the probe has sufficient length for the repositioning.

AIR INTAKE FROM THE BACK SIDE

Back side view

OVER
E1 - E2 - E3

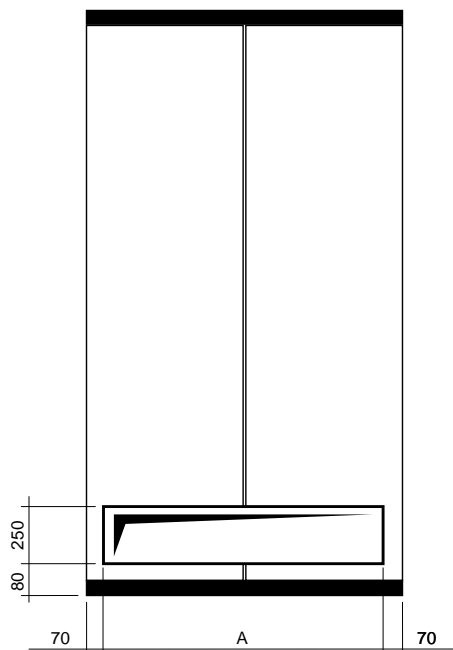

SIZE		E1	E2	E3
A	mm	510	645	945
Max air flow	m ³ /h	600	1000	1500

OPTIONAL ACCESSORIES – DOUBLE POWER SUPPLY WITH AUTOMATIC TRANSFER SWITCH



The optional is not compatible with “oversized electric heaters” and “oversized humidifier” optional accessories.

The motorised changeover switches automatically manage changeover under load between two three-phase power supplies, or manually for emergency operations.

These transfer switching (TSE) devices are suitable for low voltage systems with interruption of the supply to the load during transfer.

The model supplied in the automatic version checks the source and switches over automatically, based on configurable parameters.

OPEN TRANSITION TYPE TRANSFER SWITCH WITH A MINIMUM INTERRUPTION OF THE SUPPLY DURING TRANSFER.

To maintain the microprocessor powered and avoid its restarts is mandatory to foresee the installation of the “temporary microprocessor power supply” optional accessory. The system guarantees the microprocessor power supply for a few minutes, in case of supply voltage failure.

The remote condenser must be powered by the automatic transfer switch. The installation of “Electrical power supply for remote condenser from the indoor machine electrical board” optional accessory is requested.

ATS INSTALLATION

Frame	Power Supply	ATS Installation
E1	400/3+N/50	EXTERNAL, supplied in kit
E2	400/3+N/50	EXTERNAL, supplied in kit
E3	400/3+N/50	EXTERNAL, supplied in kit
E4L	400/3+N/50	EXTERNAL, supplied in kit
E5L	400/3+N/50	EXTERNAL, supplied in kit
E7L	400/3+N/50	INTERNAL (on unit electrical panel)
E8L	400/3+N/50	INTERNAL (on unit electrical panel)
E9L	400/3+N/50	INTERNAL (on unit electrical panel)



KIT FOR EXTERNAL INSTALLATION

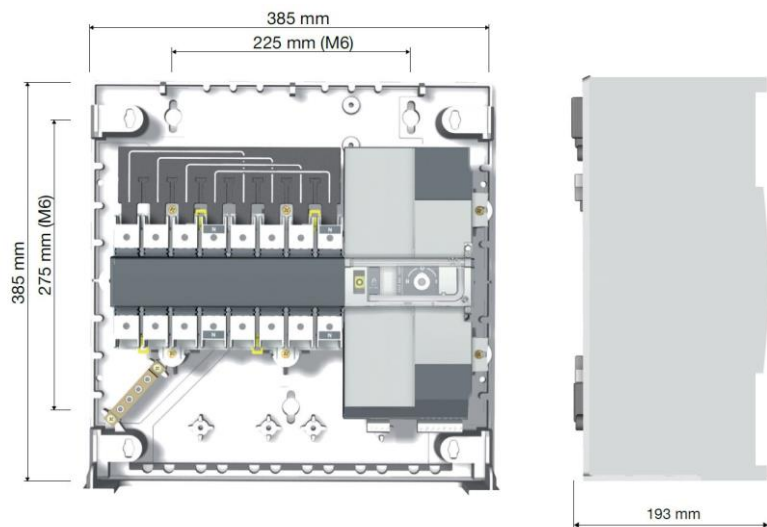

OPTIONAL ACCESSORIES – NETWORK ANALYZER



The optional is not compatible with “oversized electric heaters” and “oversized humidifier” optional accessories.

The optional is installed within the electrical box downstream the main switch with door safety lock:

- Network transducer;
- Current transformers, one for each power supply phase cable.

This device provides continuous measurement of power consumption, monitoring current, voltage and power. These values are sent to unit microprocessor via RS485 serial cable, as shown on the unit wiring diagram.

The displayed variables are:

- Phase to phase voltage, only for three-phase units;
- Phase voltage (phase-neutral);
- Phase current;
- Neutral current only for three-phase units;
- Active phase power, only for three-phase units;
- Total active power;
- Active energy;
- Hour counts

OPTIONAL ACCESSORIES – FIRE / SMOKE SENSORS

Is possible to install one or both of the following sensors. Sensors are supplied in mounting kit. Installation within the room at customer care.



SMOKE DETECTOR

The optical smoke detector senses the presence of combustion by-products (visible smoke) and activates an alarm.

The operating principle is based on the light scattering technique (Tyndall effect).

The device is in conformity to EN 54-7 standard.

Technical features:

Material	ABS
Power supply	12...28 Vdc
Normal current	50µA a 24 Vdc
Alarm current	25mA a 24 Vdc
LED visibility	360° (double led)
Storage temperature	-10...+70°C
Operating temperature	-10...+70°C
Max. speed air	0,2 m/s
Relative humidity	<93% not-condensing
Index of protection	IP 20
Testing by magnet	Yes
Relay	max. 1A 30Vdc
Signal repeater	14mA a 24 Vdc
Sensor coverage:	40m ² max
Shielded connection cable	sez. min 0,5 mm ²
Colour	White



HEAT DETECTOR

The heat detector has been designed to identify temperatures at which fires may start. When the temperature exceeds the set threshold or when there is a rapid variation in temperature, the relay is activated to signal an alarm.

The device is in conformity to EN 54-5 standard.

Technical features:

Material	ABS
Power supply	12...28 Vdc
Normal current	50µA a 24 Vdc
Alarm current	25mA a 24 Vdc
LED visibility	360° (double LED)
Storage temperature	-10...+70°C
Operating temperature	-10...+70°C
Relative humidity	<93% non-condensing
Index of protection	IP 20
Testing by magnet	Yes
Relay	max. 1A 30Vdc
Signal repeater	14mA a 24 Vdc
Alarm temperature threshold	62°C
Sensor coverage:	40m ² max
Shielded connection cable	min 0.5 mm ²
Colour	White

OPTIONAL ACCESSORIES - CONDENSATE DISCHARGE PUMP



A plastic case contains the vertical type pump, the water tank with float plus safety switch and hydraulic and electric connection.

Together the pump 10 linear meters anti-crushing plastic discharge spiral tube is supplied

The optional has to be installed as shown in the documentation delivered together with the unit.

Wiring includes power supply and an alarm, displayed on microprocessor, that includes motor pump thermal protection and tank overflow.

The condensate discharge pump operation is fully automatic.

WARNING

For all the machines the optional accessory is supplied in mounting kit.

TECHNICAL DATA

Power supply: 230V~ 50Hz

Electrical data: 70W – 0,67A

Maximum water flow: 500 l/h

Maximum delivery height: 5.0 m

Sound level: 45dBA a 1 m

Maximum water temperature: 70°C

Water acidity: pH>2.5

Tray volume: 2.0 l

Protection IP 20

CONDENSATE DISCHARGE PUMP

(Dimensions in millimetres)

OPERATING DATA

Discharge head	Total length of discharge pipes (Ø 10 mm internal)			
	5m	10m	20m	30m
1m	380	300	240	190
2m	310	260	200	150
3m	240	200	145	110
4m	150	130	80	60
5m	30	20	0	0



OPTIONAL ACCESSORIES – MODULATING STEAM HUMIDIFIER



Modulating steam humidifier with immersed electrodes fitted with safety and running accessories. The optional includes the combined temperature / humidity sensor on unit air intake. The accessory is factory installed and requires only water filling connection.

Humidifier water charge and discharge pipes are not supplied.

It is recommended to install a filter and a shut-off valve on the pipe to the water inlet.

This humidifier produces non-pressurized steam by electrodes immersed in the water inside the cylinder: they bring the electric phase in the water that works as an electrical resistance and overheats. The steam so produced is distributed with dedicated distributors and used for ambient humidification or for industrial processes.

CHARACTERISTICS OF THE SUPPLY WATER

The quality of the used water influences the evaporation process, so the humidifier can be fed with **not-treated water, only when potable and non-demineralised.**

LIMIT VALUES

		Min	Max
Hydrogen ions	pH	7	8,5
Specific conductivity at 20°C	$\sigma_{R, 20^\circ C}$ $\mu S/cm$	300	1250
Total dissolved solids	TDS mg/l	(1)	(1)
Dry residue at 180°C	R ₁₈₀ mg/l	(1)	(1)
Total hardness	TH mg/l CaCO ₃	100 (2)	400
Temporary hardness	mg/l CaCO ₃	60 (3)	300
Iron + Manganese	mg/l Fe + Mn	0	0,2
Chlorides	ppm Cl	0	30
Silica	mg/l SiO ₂	0	20
Residual chlorine	mg/l Cl ⁻	0	0,2
Calcium sulphate	mg/l CaSO ₄	0	100
Metallic impurities	mg/l	0	0
Solvents, diluents, soaps, lubricants	mg/l	0	0

(1) Values depending on specific conductivity; in general: TDS $\cong 0,93 * \sigma_{R, 20^\circ C}$; R₁₈₀ $\cong 0,65 * \sigma_{R, 20^\circ C}$
 (2) Not lower than 200% of the chloride content in mg/l di Cl⁻
 (3) Not lower than 300% of the chloride content in mg/l di Cl⁻

WARNING:

- No relation can be demonstrated between water hardness and conductivity.
- **Do not treat water with softeners!** This could cause corrosion of the electrodes or the formation of foam, leading to potential operating problems or failures.
- Do not add disinfectants or corrosion inhibitors to water, as these substances are potentially irritant.
- Is absolutely forbidden to use well water, industrial water or water drawn from cooling circuits; in general, avoid using potentially contaminated water, either from a chemical or bacteriological point of view

TECHNICAL DATA

MODEL		012 M1 S	018 M1 S	022 M1 S	030 M1 S	047 M1 S
SIZE		E1	E2	E3	E4L	E5L
VERSION (1)		U / O	U / O	U / O	U / O	U / O
VAPOUR PRODUCTION	kg/h	3,0	3,0	3,0	8,0	8,0
Power input	kW	2,3	2,3	2,3	6,0	6,0
Absorbed current (OA)	A	3,2	3,2	3,2	8,7	8,7
Max absorbed current (OA)	A	4,5	4,5	4,5	12,4	12,4
Water content	l	3,9	3,9	3,9	6,4	6,4
Max water supply pressure	Bar	1÷8	1÷8	1÷8	1÷8	1÷8
NET WEIGHT (2)	kg	4	4	4	10	10
HYDRAULIC CONNECTION						
WATER INLET - ISO 228/1 – G F	Ø	3/4"	3/4"	3/4"	-	-
WATER INLET - ISO 228/1 – G M	Ø	-	-	-	3/4"	3/4"
WATER OUTLET – internal diameter	Ø mm	19	19	19	-	-
WATER OUTLET – external diameter	Ø mm	-	-	-	19	19

1. U = Under, downflow / O = Over, upflow
 2. Value to be added to the weight of the standard unit. Does not include the weight of the water content.



TECHNICAL DATA

MODEL		042 M2 D	068 M2 D	094 M2 D	120 M4 D	150 M4 D
SIZE		E5L	E7L	E8L	E9L	E9L
VERSION (1)		U / O	U / O	U / O	U	U
VAPOUR PRODUCTION	kg/h	8,0	8,0	8,0	8,0	8,0
Power input	kW	6,0	6,0	6,0	6,0	6,0
Absorbed current (OA)	A	8,7	8,7	8,7	8,7	8,7
Max absorbed current (OA)		12,4	12,4	12,4	12,4	12,4
Water content	l	6,4	6,4	6,4	6,4	6,4
Max water supply pressure	Bar	1÷8	1÷8	1÷8	1÷8	1÷8
NET WEIGHT (2)	kg	10	10	10	10	10
HYDRAULIC CONNECTION						
WATER INLET - ISO 228/1 – G F	Ø	-	-	-	-	-
WATER INLET - ISO 228/1 – G M	Ø	3/4"	3/4"	3/4"	3/4"	3/4"
WATER OUTLET – internal diameter	Ø mm	-	-	-	-	-
WATER OUTLET – external diameter	Ø mm	19	19	19	19	19

1. U = Under, downflow / O = Over, upflow
2. Value to be added to the weight of the standard unit. Does not include the weight of the water content.

OVERSIZED HUMIDIFIERS

The optional is not available for size E1, E2, E3.

On request, it is possible to install the oversized humidifiers system.

The components are the same of the standard accessory

TECHNICAL DATA

MODEL		012 M1 S	018 M1 S	022 M1 S	030 M1 S	047 M1 S
SIZE		E1	E2	E3	E4L	E5L
VERSION (1)		U / O	U / O	U / O	O	U / O
VAPOUR PRODUCTION	kg/h	--	--	--	15,0	15,0
Power input	kW	--	--	--	11,3	11,3
Absorbed current (OA)	A	--	--	--	16,2	16,2
Max absorbed current (OA)	A	--	--	--	23	23
Water content	l	--	--	--	10,3	10,3
Max water supply pressure	Bar	--	--	--	1÷8	1÷8
NET WEIGHT (2)	kg	--	--	--	16	16
HYDRAULIC CONNECTION						
WATER INLET - ISO 228/1 – G F	Ø	--	--	--	-	-
WATER INLET - ISO 228/1 – G M	Ø	--	--	--	3/4"	3/4"
WATER OUTLET – internal diameter	Ø mm	--	--	--	-	-
WATER OUTLET – external diameter	Ø mm	--	--	--	19	19

TECHNICAL DATA

MODEL		042 M2 D	068 M2 D	094 M2 D	120 M4 D	150 M4 D
SIZE		E5L	E7L	E8L	E9L	E9L
VERSION (1)		U / O	U / O	U / O	U	U
VAPOUR PRODUCTION	kg/h	15,0	15,0	15,0	15,0	15,0
Power input	kW	11,3	11,3	11,3	11,3	11,3
Absorbed current (OA)	A	16,2	16,2	16,2	16,2	16,2
Max absorbed current (OA)	A	23	23	23	23	23
Water content	l	10,3	10,3	10,3	10,3	10,3
Max water supply pressure	Bar	1÷8	1÷8	1÷8	1÷8	1÷8
NET WEIGHT (2)	kg	16	16	16	16	16
HYDRAULIC CONNECTION						
WATER INLET - ISO 228/1 – G F	Ø	-	-	-	-	-
WATER INLET - ISO 228/1 – G M	Ø	3/4"	3/4"	3/4"	3/4"	3/4"
WATER OUTLET – internal diameter	Ø mm	-	-	-	-	-
WATER OUTLET – external diameter	Ø mm	19	19	19	19	19

1. U = Under, downflow / O = Over, upflow
2. Value to be added to the weight of the standard unit. Does not include the weight of the water content.

OPTIONAL ACCESSORIES – DEHUMIDIFICATION SYSTEM

Components:

- Temperature / Humidity sensor on the air intake.
- Electronic control system of the dew point temperature for the combined intervention of cooling capacity and air flow.

OPTIONAL ACCESSORIES - 2-WAY MOTORIZED VALVE FOR CONDENSING CONTROL

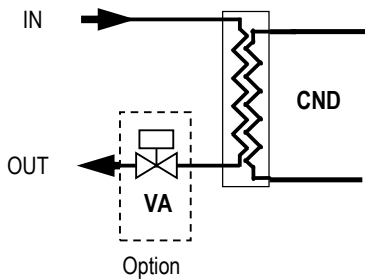

CND Condenser
VA Condensing control valve

The optional accessory, installed on the condenser outlet side, includes a 2-way motorized valve for condensing control with 0=10 VDC control actuator and emergency manual control.

The water flow control in the condenser is achieved through a 2-way modulating ball valve with equal percentage flow control ensured by the integrated characterizing disc.

This type of valve offers the following series of benefits:

- Equal percentage flow control.
- Closing seal with leakage rate in Class A (EN 12266-1)
- No peaks initial flow.
- Excellent stability control thanks to the integrated characterizing disc.
- Closing pressure very high.
- Excellent characteristic in partialisation.
- Stability in control.
- Wide operating pressures which provide an optimal adjustment of the water flow even under extreme conditions.
- Maintenance free.
- Self-cleaning.

The rotative actuator is controlled by a signal 0 ... 10VDC from the microprocessor controller. The actuator is equipped with an emergency button for manual operation and is maintenance-free.

TECHNICAL DATA

MODEL	012 M1 S	018 M1 S	022 M1 S	030 M1 S	047 M1 S
SIZE	E1	E2	E3	E4L	E5L
VERSION (1)	U / O	U / O	U / O	U / O	U / O
CONDENSING CONTROL VALVE					
k_v – Flow coefficient	m ³ /h	4,0	6,3	6,3	10,0

MODEL	042 M2 D	068 M2 D	094 M2 D	120 M4 D	150 M4 D
SIZE	E5L	E7L	E8L	E9L	E9L
VERSION (1)	U / O	U / O	U / O	U	U
CONDENSING CONTROL VALVE					
k_v – Flow coefficient	m ³ /h	16,0	25,0	25,0	40,0

1. U = Under, downflow / O = Over, upflow

IMPORTANT

For further information, please refer to chapter “VALVE PRESSURE DROP CALCULATION AS FUNCTION OF WATER FLOW RATE”



OPTIONAL ACCESSORIES – ELECTRIC HEATERS



Electric heater consisting of finned aluminum elements, ensuring low surface temperature and deleting the air ionization problems. The optional is installed downstream the main cooling coil.

In electric heaters with three working steps the activation is binary type.

Components:

- Electric heater in aluminium armoured elements with integral fins
- Electrical control
- Safety thermostat.

The electric heater can be installed in combination with the hot water heating coil. The operation is alternate with priority to the hot water heating coil.

The electric heater can be installed in combination with the hot gas re-heating system. The operation is alternate with priority to the hot gas re-heating system. In this configuration the electric heater groups the operating stages in a single step.

TECHNICAL DATA

MODEL		012 M1 S	018 M1 S	022 M1 S	030 M1 S	047 M1 S
SIZE		E1	E2	E3	E4L	E5L
VERSION (1)		U / O	U / O	U / O	U / O	U / O
THERMAL CAPACITY	kW	5,1	5,1	6,0	9,0	13,5
Absorbed current (OA)	A	7,4	7,4	8,7	13,0	19,5
First working step	kW	5,1	5,1	3,0	3,0	4,5
Second working step	kW	-	-	3,0+3,0	6,0	9,0
Third working step	kW	-	-	-	3,0 + 6,0	4,5+9,0
NET WEIGHT (2)	kg	4	4	7	15	10

MODEL		042 M2 D	068 M2 D	094 M2 D	120 M4 D	150 M4 D
SIZE		E5L	E7L	E8L	E9L	E9L
VERSION (1)		U / O	U / O	U / O	U	U
THERMAL CAPACITY	kW	13,5	13,5	18,0	18,0	18,0
Absorbed current (OA)	A	19,5	19,5	26,0	26,0	26,0
First working step	kW	4,5	4,5	4,5	4,5	4,5
Second working step	kW	9,0	9,0	13,5	13,5	13,5
Third working step	kW	4,5+9,0	4,5+9,0	4,5+13,5	4,5+13,5	4,5+13,5
NET WEIGHT (2)	kg	10	9,5	11	11	11

OVERSIZED ELECTRIC HEATERS

The optional is not available for size E1, E2

On request, it is possible to install the oversized electric heating system.

The components are the same of the standard accessory

It is not possible to combine the oversized electric heaters with the hot water heating coil or the hot gas re-heating system.

TECHNICAL DATA

MODEL		012 M1 S	018 M1 S	022 M1 S	030 M1 S	047 M1 S
SIZE		E1	E2	E3	E4L	E5L
VERSION (1)		U / O	U / O	U / O	U / O	U / O
THERMAL CAPACITY	kW	-	-	9,0	13,5	18,0
Absorbed current (OA)	A	-	-	13,0	13,0	26,0
First working step	kW	-	-	4,5	4,5	4,5
Second working step	kW	-	-	4,5+4,5	9,0	13,5
Third working step	kW	-	-	-	4,5+9,0	4,5+13,5
NET WEIGHT (2)	kg	-	-	7	9,5	12

MODEL		042 M2 D	068 M2 D	094 M2 D	120 M4 D	150 M4 D
SIZE		E5L	E7L	E8L	E9L	E9L
VERSION (1)		U / O	U / O	U / O	U	U
THERMAL CAPACITY	kW	18,0	18,0	27,0	27,0	27,0
Absorbed current (OA)	A	26,0	26,0	39,0	39,0	39,0
First working step	kW	4,5	4,5	9,0	9,0	9,0
Second working step	kW	13,5	13,5	18,0	18,0	18,0
Third working step	kW	4,5+13,5	4,5+13,5	9,0+18,0	9,0+18,0	9,0+18,0
NET WEIGHT (2)	kg	12	11,5	14,5	14,5	14,5

1. U = Under, downflow / O = Over, upflow

2. Value to be added to the weight of the standard unit.

OPTIONAL ACCESSORIES - HOT GAS RE-HEATING SYSTEM

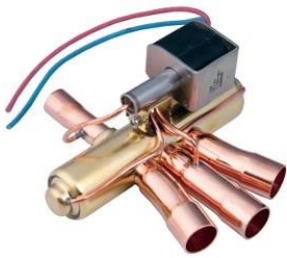

The optional is not compatible with "hot water heating system".
 In presence of normal or extraordinary variations of the room thermal load, it can be necessary to control an increase in the relative humidity value, by adding sensible heat to the pre-cooled and pre-dehumidified air.
 To achieve this result, it is possible to take advantage of part of the heat of condensation given by the operation of the cooling circuit which has to be dissipated anyway.
 This system is energy conscious since it does not require any other electric energy but that already consumed by the compressor.
 The necessary heat is obtained by the partial deviation of the compressor hot gas discharge into heat exchange coil, installed downstream the cooling coil, so that heat is transferred to the air being handled. The gas is then brought back into the main circuit via the dissipation system (air cooled or water-cooled condenser).
 It is equipped with ON/OFF control of the quantity of heat provided by the re-heating coil.
 The system looks like a derivation of the main gas circuit and it is formed by a 4-way valve positioned on the compressor discharge side.
 Heat transfer is achieved through a heat exchanger placed immediately after the evaporating coil.
 Upon a re-heating request from the microprocessor control system, the 4-way valve divert the hot gas through the re-heating coil.
 This causes a temperature increase in the leaving air from the evaporating coil.
 The refrigerant gas is then brought to the condenser and then back to the evaporating coil.
 During normal working conditions, the 4-way valve does not allow the passage of the hot gas through the re-heating coil by ensuring it enters directly into the condensing system.
 In case of failure of the 4-way valve, the valve automatically positions itself to completely exclude the re-heating system.
The system is not available for machines with double refrigerant circuit.

The hot gas re-heating system can be installed in combination with the electric heater. The operation is alternate with priority to the hot gas re-heating system. In this configuration the electric heater groups the operating stages in a single step.

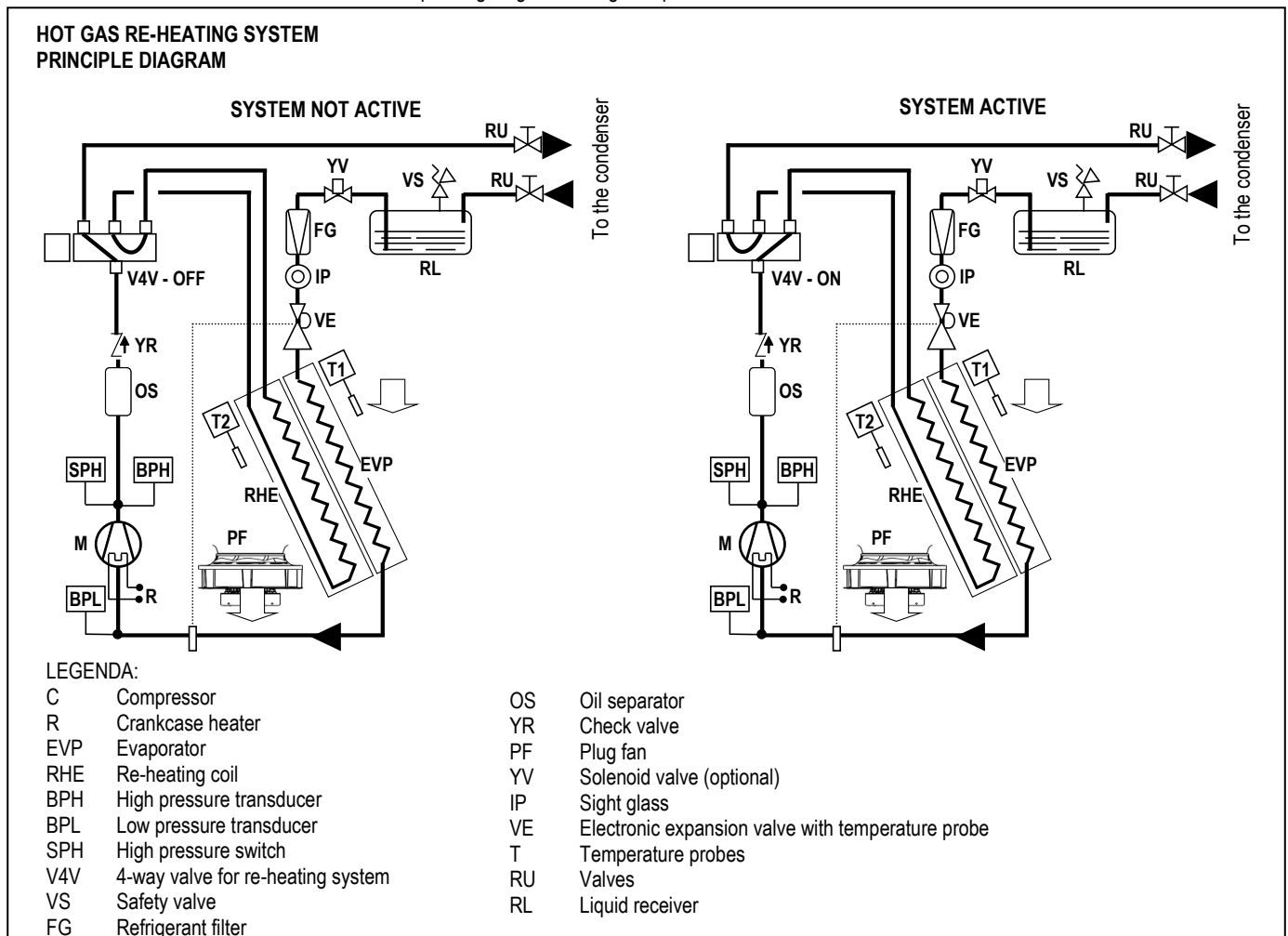

TECHNICAL DATA

MODEL	012 M1 S					018 M1 S					
SIZE	E1					E2					
VERSION (1)	U / O					U / O					
THERMAL CAPACITY	100%	80%	60%	40%	30%	100%	80%	60%	40%	30%	
Total thermal capacity	kW	8,57	6,87	5,19	3,49	2,55	16,97	13,78	10,33	6,94	5,37

MODEL	022 M1 S					030 M1 S					
SIZE	E3					E4L					
VERSION (1)	U / O					U / O					
THERMAL CAPACITY	100%	80%	60%	40%	30%	100%	80%	60%	40%	30%	
Total thermal capacity	kW	20,08	15,88	12,01	7,69	5,65	33,01	26,38	19,82	13,19	10,00

MODEL	047 M1 S					042 M2 D					
SIZE	E5L					E5L					
VERSION (1)	U / O					U / O					
THERMAL CAPACITY	100%	80%	60%	40%	30%	100%	80%	60%	40%	30%	
Total thermal capacity	kW	44,60	36,29	27,22	18,14	14,20	--	--	--	--	--

MODEL	068 M2 D					094 M2 D					
SIZE	E7L					E8L					
VERSION (1)	U / O					U / O					
THERMAL CAPACITY	100%	80%	60%	40%	30%	100%	80%	60%	40%	30%	
Total thermal capacity	kW	--	--	--	--	--	--	--	--	--	--

MODEL	120 M4 D					150 M4 D					
SIZE	E9L					E9L					
VERSION (1)	U					U					
THERMAL CAPACITY	100%	80%	60%	40%	30%	100%	80%	60%	40%	30%	
Total thermal capacity	kW	--	--	--	--	--	--	--	--	--	--

The optional accessory modifies the weight of the standard unit.

1. U = Under, downflow / O = Over, upflow

OPTIONAL ACCESSORIES – HOT WATER HEATING SYSTEM



Hot water heating system installed downstream the main cooling coil.
 The optional is not compatible with "hot gas reheating system".
 The optional accessory is factory installed and don't modify the overall dimensions of the unit.
 Components:

- Heat exchanger coil with internally corrugated copper tubes and high efficiency aluminium fins, specifically developed to provide high heat transfer and lower pressure drops.
- 2-way motorized valve for water flow regulation with 0÷10 VDC control actuator and emergency manual control.
- Temperature probes on water inlet
- Frame in galvanized steel.

The hot water heating coil can be installed in combination with the electric heater. The operation is alternate with priority to the hot water heating coil.

About water quality, please refer to chapter "WATER QUALITY"

TECHNICAL DATA

MODEL		012 M1 S	018 M1 S	022 M1 S	030 M1 S	047 M1 S
SIZE		E1	E2	E3	E4L	E5L
VERSION (1)		U / O	U / O	U / O	U / O	U / O
THERMAL CAPACITY (2)	kW	24,7	34,2	45,2	69,2	106,0
HEATING COIL						
Water flow rate (2)	m ³ /h	1,45	2,0	2,7	4,1	6,2
dP coil + valve (2)	kPa	29	24	24	11	27
Water volume	l	2,6	2,6	3,9	6,9	9,1
NET WEIGHT (3)	kg	15	18	25	35	42
HYDRAULIC CONNECTIONS						
WATER INLET / OUTLET ISO 7/1 - R	Ø	3/4"	3/4"	1"	1 1/4"	1 1/2"

MODEL		042 M2 D	068 M2 D	094 M2 D	120 M4 D	150 M4 D
SIZE		E5L	E7L	E8L	E9L	E9L
VERSION (1)		U / O	U / O	U / O	U	U
THERMAL CAPACITY (2)	kW	106,0	146,0	181,0	236,0	236,0
HEATING COIL						
Water flow rate (2)	m ³ /h	6,2	8,6	10,6	13,80	13,80
dP coil + valve (2)	kPa	27	16	25	43	43
Water volume	l	9,1	12,3	18,2	16,9	16,9
NET WEIGHT (3)	kg	42	57	88	75	75
HYDRAULIC CONNECTIONS						
WATER INLET / OUTLET ISO 7/1 - R	Ø	1 1/2"	2 1/2"	2 1/2"	2"	2"

1. U = Under, downflow / O = Over, upflow
2. Characteristics referred to entering air at 20°C with hot water temperature 75/60°C - 0% glycol.
3. Value to be added to the weight of the standard unit. Does not include the weight of the water content.

HOT WATER HEATING HYDRAULIC / REFRIGERANT CIRCUIT

UNDER - SINGLE REFRIGERANT CIRCUIT

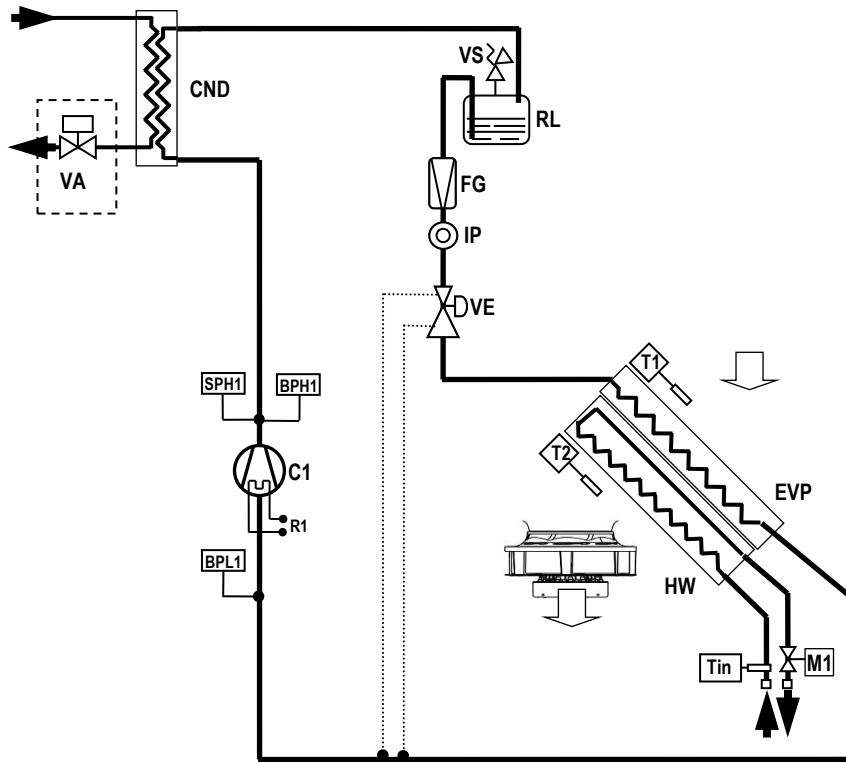

OVER - SINGLE REFRIGERANT CIRCUIT

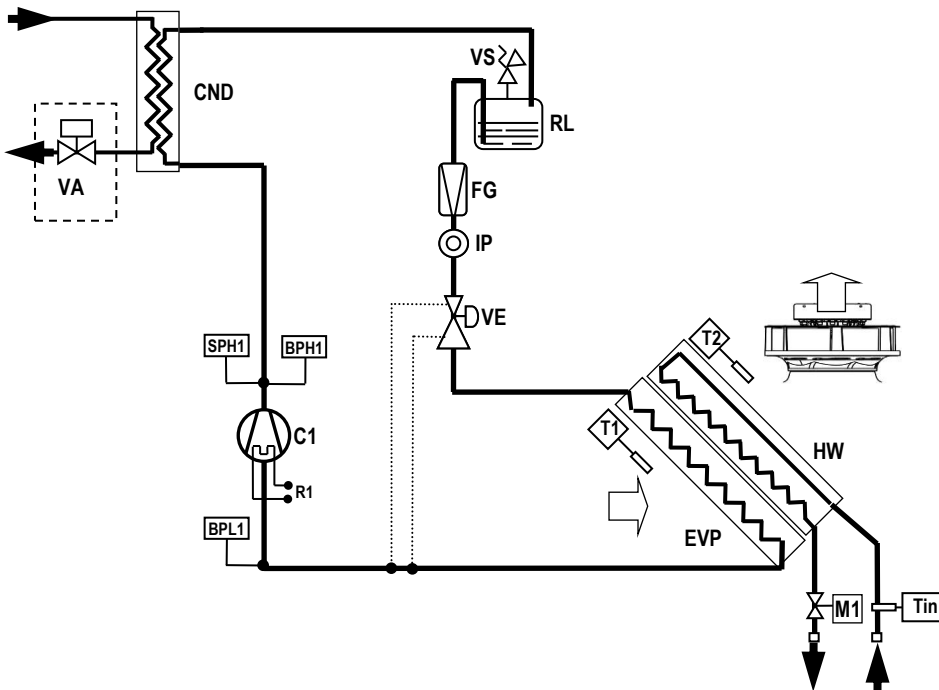

LEGENDA

C1	BLDC inverter compressor	BPL	Low pressure transducer.	IP	Sight glass.
R1	Crankcase heater	VA	2-way valve for condensing control	VE	Expansion valve.
CND	Condenser.	SPH	High pressure switch	T	Temperature probes.
EVP	Evaporator	M1	Hot water 2-way valve	RU	Valves
HW	Hot water coil	VS	Safety valve.	RL	Liquid receiver
BPH	High pressure transducer.	FG	Refrigerant filter.		



HOT WATER HEATING HYDRAULIC / REFRIGERANT CIRCUIT

UNDER - DOUBLE REFRIGERANT CIRCUIT

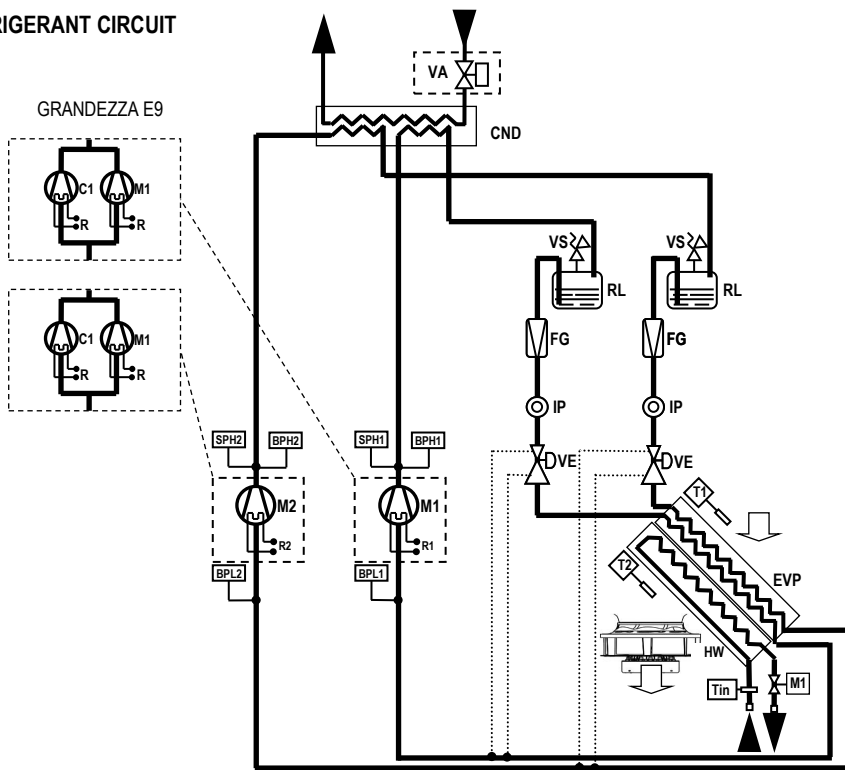

OVER - DOUBLE REFRIGERANT CIRCUIT

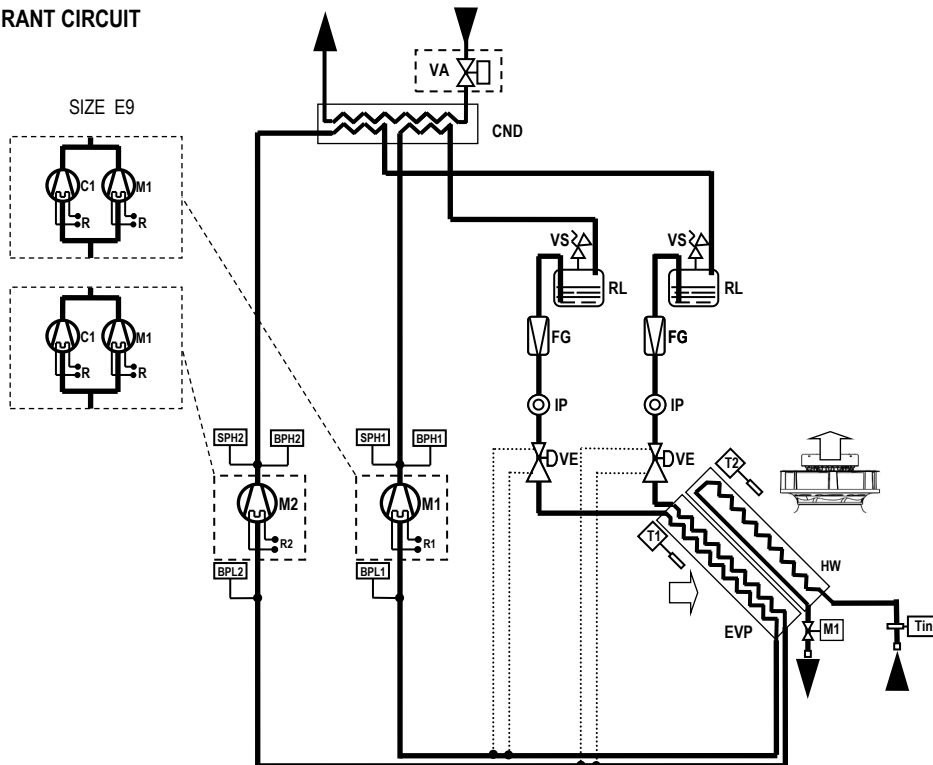

LEGENDA

M1...2	BLDC inverter compressor 1, 2	BPH	High pressure transducer.	IP	Sight glass.
C1...2	On/off compressor 1, 2	BPL	Low pressure transducer.	VE	Expansion valve.
R1...2	Crankcase heater 1, 2	SPH	High pressure switch	T	Temperature probes.
CND	Condenser.	M1	Hot water 2-way valve	RU	Valves
EVP	Evaporator	VS	Safety valve.	RL	Liquid receiver
HW	Hot water coil	FG	Refrigerant filter.		



OPTIONAL ACCESSORIES - FLOOR STAND

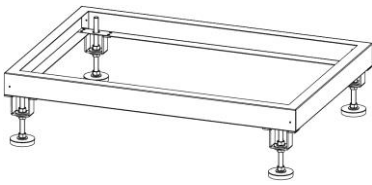

The accessory is supplied as an assembly kit.
 It is not possible to match the unit floor stand with plenum installed under the machine.
 For a correct installation of the air conditioner we suggest you utilize a gasket between the floor stand and the unit base.
 The floor stand is available in 3 different heights.

SIZE E1 - E2 - E3

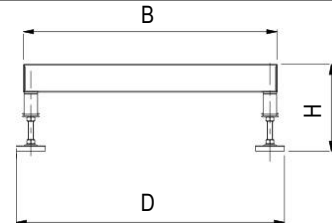
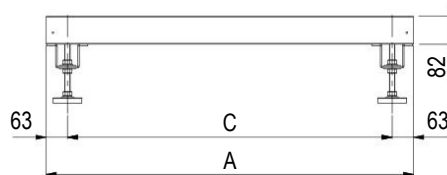

SIZE E4L - E5L

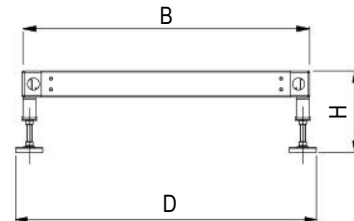
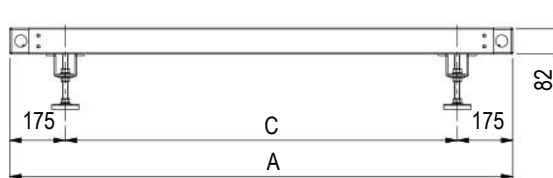

SIZE E7L - E8L - E9L

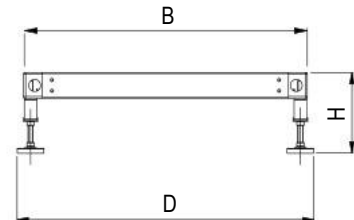
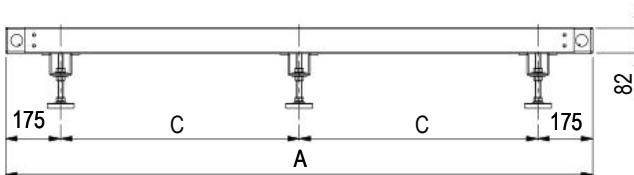

SIZE		E1	E2	E3	E4L	E5L	E7L	E8L	E9L
VERSION (1)		U / O	U / O	U / O	U / O	U / O	U / O	U / O	U
A	mm	650	785	1085	1630	1955	2499	2899	3299
B	mm	650	650	750	905	905	905	905	905
C	mm	524	659	959	1280	1605	1074,5	1274,5	1474,5
D	mm	691	691	791	945	945	945	945	945

MODEL		Hmax350	Hmax450	Hmax510
H min height	mm	255	355	400
H max height	mm	350	450	510

1. U = Under, downflow / O = Over, upflow

OPTIONAL ACCESSORIES - DOUBLE PANELS IN EUROCLASS A1

The optional is designed to supply the panels only in Euroclass A1 of reaction to fire, furthermore allows a noise insulation of the panels of the air conditioners.

The pressure level reduction of the unit is about 2 dB(A). The reduction refers ONLY to the sound level radiated from the unit or in front of the unit. The noise level data on return and delivery air do not undergo reductions.

The accessory includes:

- External part as standard panel.
- Internal part in galvanized steel sheet.
- The inside noise insulation with special soundproof material.

REACTION TO FIRE CLASSIFICATION

On Italian territory, the classification is per the D.M. of June 26, 1984 and subsequent amendments, providing for a sort in "Classes" from 0 (non-combustible material) to 5 (extremely flammable material). In Europe, the classification is regulated per UNI EN 13501-1: 2009 ordered to "Euro-classes", from A1 (non-combustible material) to F (highly flammable material).

A comparison of the Italian and European classes is not possible because the methods and evaluation criteria are completely different. The comparison table below is being considered purely indicative.

Definition	Italian classes	Euro-classes
Non-combustible material	Class 0	A1
Combustible material, very limited contribution to fire	Class 1	A2 – B
Combustible material, limited contribution to fire	Class 2	A2 – B - C
Combustible material, medium contribution to fire	Class 3	C – D
Combustible material, highly contribution to fire	Class 4	E
Combustible material, easily flammable	Class 5	F

Is possible to provide the sandwich panels for the OVER units with air flow from the top. This implies that the air intake must necessarily be from the base of the unit with front blind paneling.

The accessory increase the unit weight:

OVER									
Size		E1	E2	E3	E4L	E5L	E7L	E8L	E9L
Weight increasing (1)	kg	30	42	48	64	72	100	115	--

UNDER									
Size		E1	E2	E3	E4L	E5L	E7L	E8L	E9L
Weight increasing (1)	kg	26	48	55	70	86	130	145	165

1. Add this value to the total unit weight

OPTIONAL ACCESSORIES – ePM₁₀ 50% EFFICIENCY AIR FILTERS

The PM₁₀ 50% air filters (according to ISO EN 16890), replace the standard one. The filters generate a pressure drops higher than the standard ones. The filters are made of glass micro-fibre and are not regenerable.

MODEL		012 M1 S	018 M1 S	022 M1 S	030 M1 S	047 M1 S
SIZE		E1	E2	E3	E4L	E5L
VERSION (1)		U / O	U / O	U / O	U / O	U / O
Additional pressure drops (2)	Pa	48	68	43	22	34

MODEL		042 M2 D	068 M2 D	094 M2 D	120 M4 D	150 M4 D
SIZE		E5L	E7L	E8L	E9L	E9L
VERSION (1)		U / O	U / O	U / O	U	U
Additional pressure drops (2)	Pa	34	40	48	74	74

1. U = Under, downflow / O = Over, upflow
2. Additional pressure drops referred to nominal air flow and clean filter.



OPTIONAL ACCESSORIES – NON-RETURN MOTORIZED DAMPER

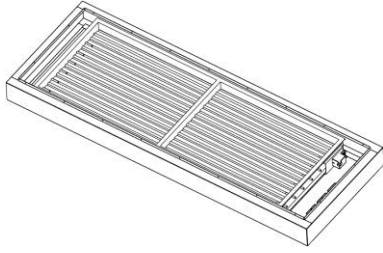

Accessory to install on units air delivery and it can be matched to plenums and floor stand.

FRAMEWORK

- Frame in galvanized steel sheet with protective surfaces treatment in compliance with UNI ISO 9227/ASTMB117 and ISO 7253, and painted with epoxy powders. Colour RAL 9005;
- Opposed blade dampers in galvanized steel sheet.
- Actuator for damper control.
- Terminals for electric connection to the unit.

For a correct installation, we suggest you to utilize a gasket between the damper and the plenum or the floor stand.

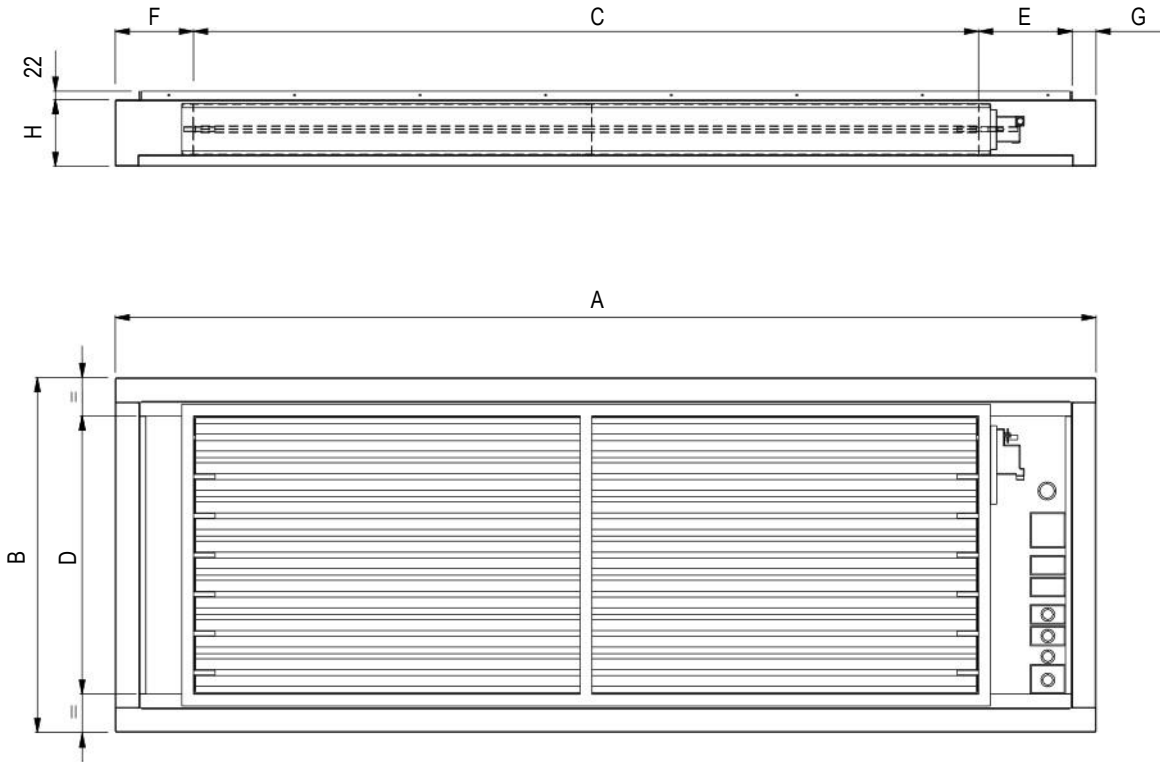

SIZE		E1	E2	E3	E4L	E5L	E7L	E8L	E9L
VERSION (1)		U / O	U / O	U / O	U / O	U / O	U / O	U / O	U
A	mm	650	785	1085	1630	1955	2499	2899	3299
B	mm	650	650	750	905	905	905	905	905
C	mm	300	450	750	900	1250	1750	2000	2300
D	mm	510	510	610	710	710	710	710	710
E	mm	231	216	216	467	529	550,5	638,5	638,5
F	mm	73	73	73	202	115	137,5	199,5	299,5
G	mm	46	46	46	61	61	61	61	61
H	mm	170	170	170	170	170	170	170	170
Weight (2)	kg	20	23	30	45	55	70	80	90

1. U = Under, downflow / O = Over, upflow
 2. Add this value to the total unit weight

INSTALLATION EXAMPLE

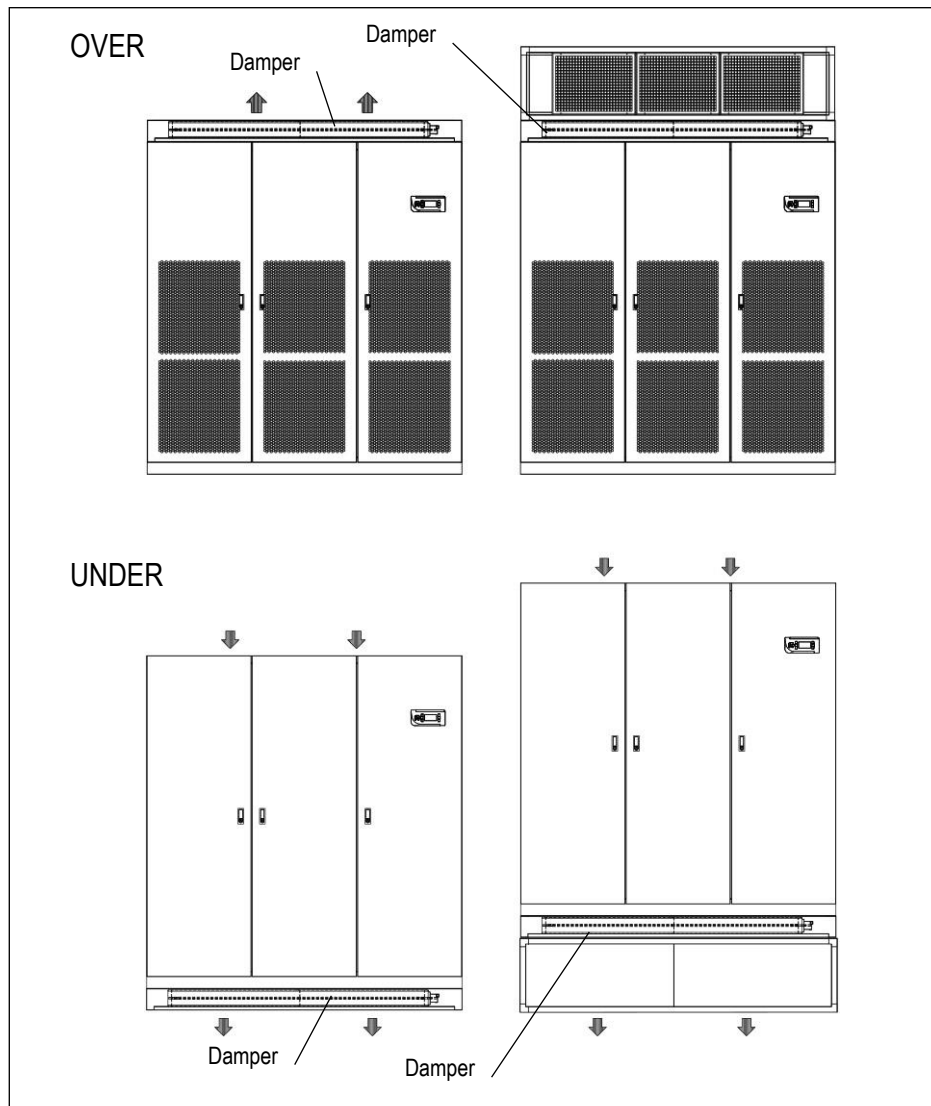

WORKING LOGIC

The damper opens at supply fans activation to allow air flow.

When the fans stop for failure or stop command, the damper closes, preventing air flow into the unit.

OPTIONAL ACCESSORIES - PLENUM ON AIR DELIVERY/RETURN

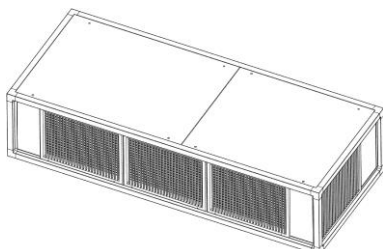
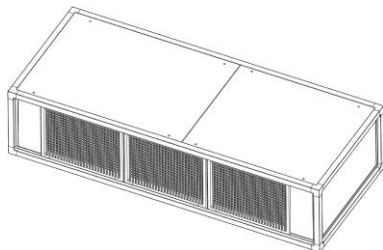
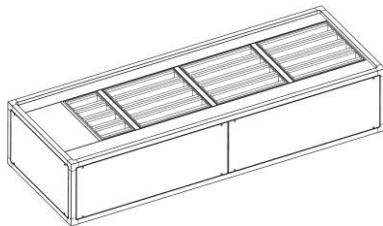
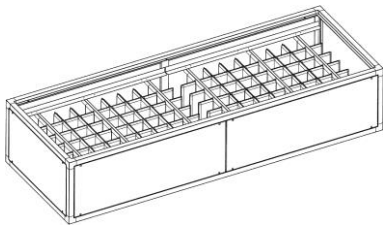
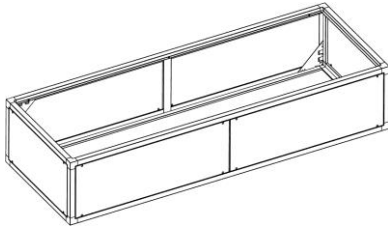

The optional is supplied separately and the installation on the unit is at Customer care.
The plenums can be used for versions Over and Under, both on supply and return air.
The plenums have same technical characteristics and dimensions of the machine cabinet.

It is possible to install only a single plenum to ensure stability to the unit.

FRAMEWORK

- Frame in aluminium extrusion, painted with epoxy powders. Colour RAL 9005;
- Panels in galvanized steel sheet with protective surfaces treatment in compliance with UNI ISO 9227/ASTMB117 and ISO 7253, and painted with epoxy powders. Colour RAL 9005;
- Panels insulated with polyurethane foam and seals to ensure air tight.
- Panels fixed with screws.
- Removable panels.
- Set of fixing elements to fasten the plenum to the unit.

Type of plenum:

- Empty plenum. Available in Euroclass A1.
- Plenum with noise absorption partitions
- Plenum with high efficiency filters.
- Plenum with frontal grille. Available in Euroclass A1.
- Plenum with frontal and lateral grilles. Available in Euroclass A1.
- Plenum with frontal grille and noise absorption partitions

WARNING

In UNDER version units the hydraulic piping is inside the machine.

The air delivery plenums sometime don't allow the extension of the pipes downwards.

In special cases, to keep the connections inside the machine, foresee a plenum 200mm higher than the standard one.

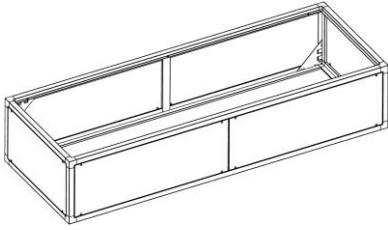

EMPTY PLENUM

The plenum is void and can be used to rise the return air inlet/outlet.
Remove the frontal panels for inspection.

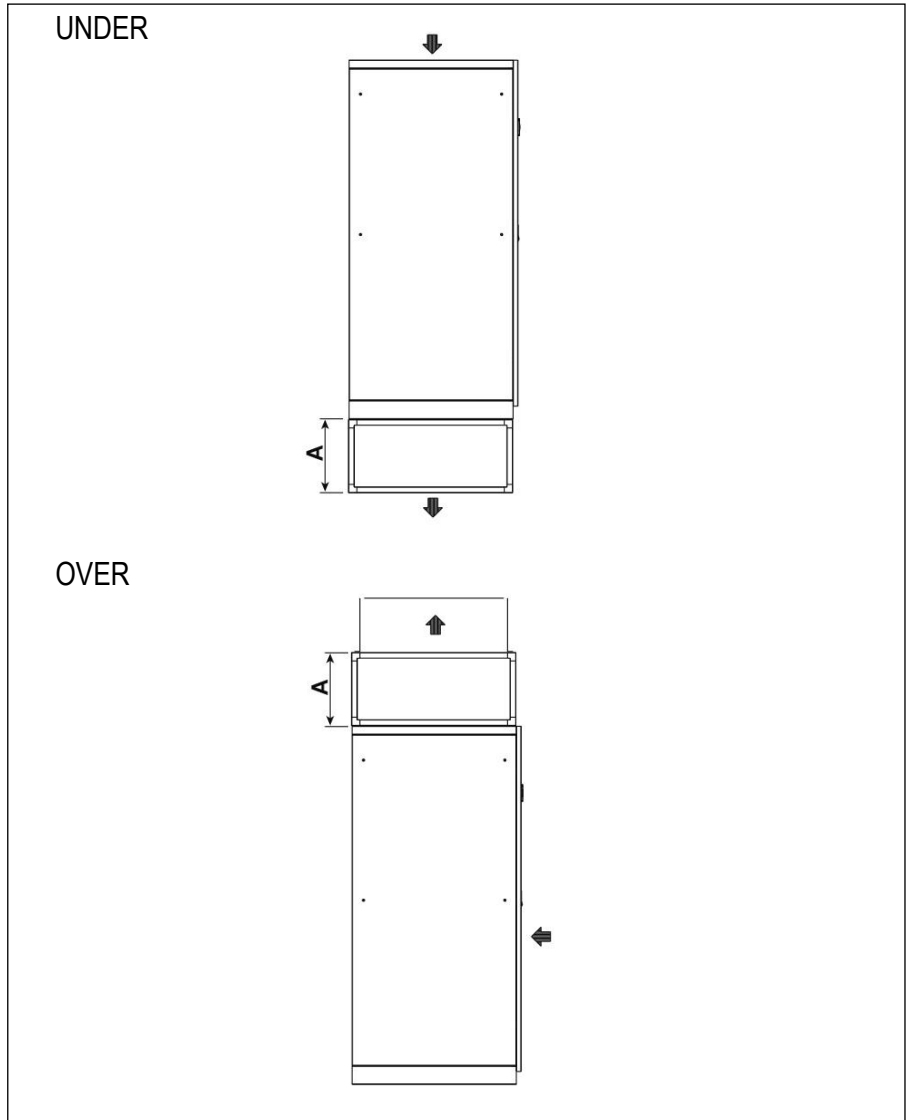

SIZE		E1	E2	E3	E4L	E5L	E7L	E8L	E9L
VERSION (1)		U / O	U / O	U / O	U / O	U / O	U / O	U / O	U
A	mm	490	490	490	510	510	510	510	510
Weight (2)	kg	20	21	20	40	45	60	70	80

**EMPTY PLENUM
REACTION TO FIRE - EUROCLASS A1**

SIZE		E1	E2	E3	E4L	E5L	E7L	E8L	E9L
VERSION (1)		U / O	U / O	U / O	U / O	U / O	U / O	U / O	U
A	mm	490	490	490	510	510	510	510	510
Weight (2)	kg	25	27	27	50	56	74	85	97

1. U = Under, downflow / O = Over, upflow
2. Add this value to the total unit weight



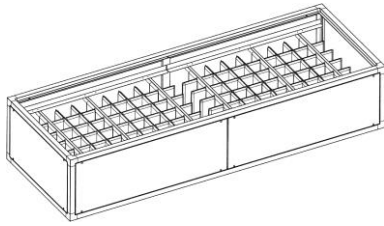

PLENUM ON AIR DELIVERY WITH NOISE ABSORPTION PARTITIONS

The plenum is fitted with noise absorption partitions to reduce the noise emission.
Remove the frontal panels for inspection.

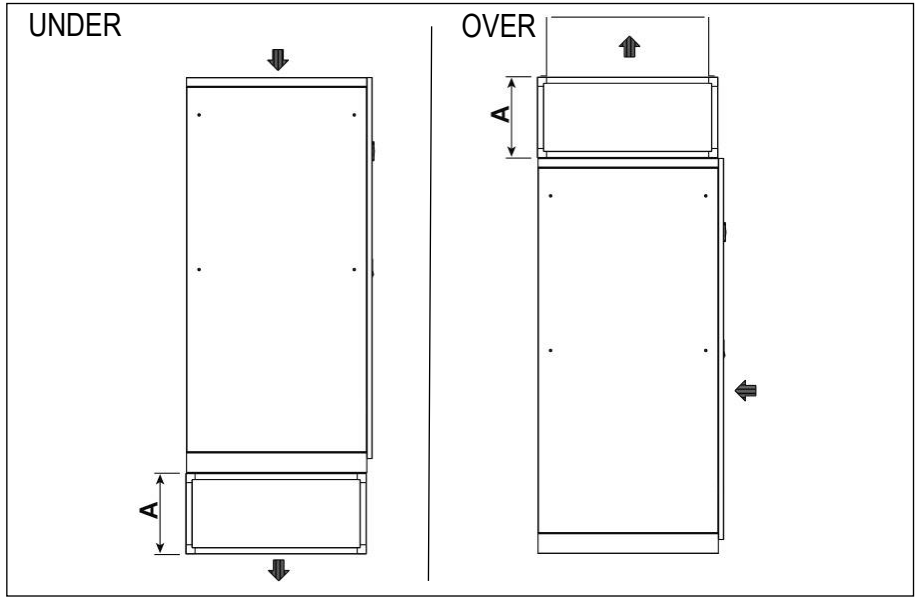

SIZE		E1	E2	E3	E4L	E5L	E7L	E8L	E9L
VERSION (1)		U / O	U / O	U / O	U / O	U / O	U / O	U / O	U
A	mm	490	490	490	510	510	510	510	510
Weight (2)	kg	25	27	30	50	55	90	100	110

1. U = Under, downflow / O = Over, upflow
2. Add this value to the total unit weight

ACOUSTIC DATA

MODEL		012 M1 S	018 M1 S	022 M1 S	030 M1 S	047 M1 S
SIZE		E1	E2	E3	E4L	E5L
SOUND LEVEL ISO 3744 (1)						
On air delivery, Under	dB(A)	61,0	67,3	64,1	70,5	77,1
On air intake, Under	dB(A)	55,4	57,6	54,4	60,7	68,8
On front side, Under	dB(A)	46,2	48,1	44,8	51,1	59,3
On air delivery, Over	dB(A)	61,0	60,6	61,2	66,6	77,1
On air intake, Over (2)	dB(A)	53,2	47,5	48,5	52,2	63,4
On front side, Over (3)	dB(A)	45,7	41,4	41,7	47,1	59,3
Air flow (4)	m ³ /h	2700	4100	5100	7500	12000

MODELLO		042 M2 D	068 M2 D	094 M2 D	120 M4 D	150 M4 D
GRANDEZZA		E5L	E7L	E8L	E9L	E9L
LIVELLO SONORO ISO 3744 (1)						
On air delivery, Under	dB(A)	77,1	73,0	78,1	79,1	79,1
On air intake, Under	dB(A)	68,8	64,6	69,7	70,9	70,9
On front side, Under	dB(A)	59,3	55,2	60,3	61,4	61,4
On air delivery, Over	dB(A)	77,1	73,0	78,1	-	-
On air intake, Over (2)	dB(A)	63,4	59,5	64,5	-	-
On front side, Over (3)	dB(A)	59,3	55,2	60,3	-	-
Air flow (4)	m ³ /h	12000	17500	22000	32000	32000

1. Noise pressure level at 1 meter in free field – ISO 3744
2. Air intake from the front
3. Air intake from the bottom
4. Nominal air flow with noise absorption partitions plenum installation and external static pressure 20 Pa.



PLENUM ON AIR RETURN WITH NOISE ABSORPTION PARTITIONS

Available only for UNDER version

The plenum is fitted with noise absorption partitions to reduce the noise emission.
Remove the frontal panels for inspection.

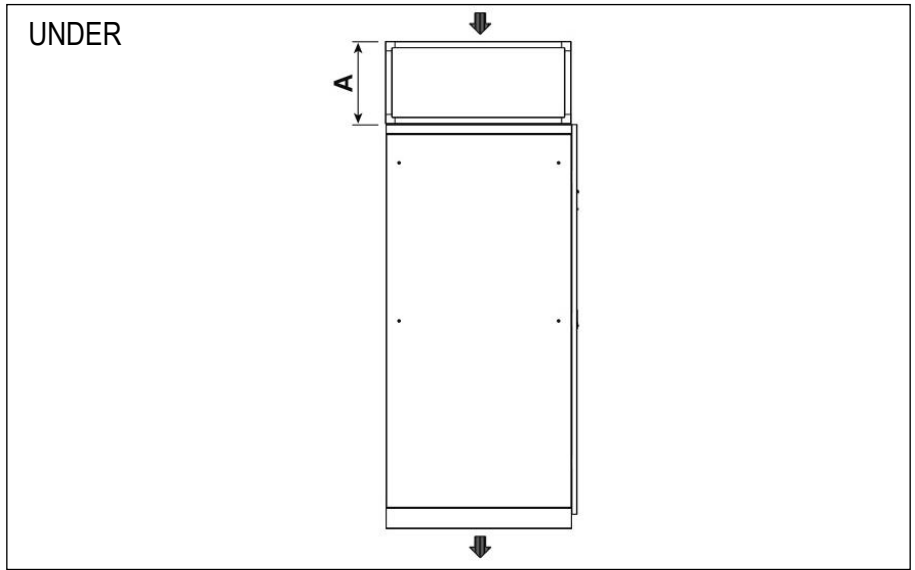
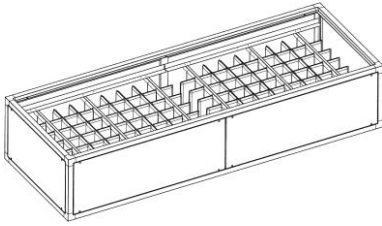

SIZE		E1	E2	E3	E4L	E5L	E7L	E8L	E9L
VERSION (1)		U / O	U / O	U / O	U / O	U / O	U / O	U / O	U
A	mm	490	490	490	510	510	510	510	510
Weight (2)	kg	25	27	30	50	55	90	100	110

1. U = Under, downflow / O = Over, upflow
2. Add this value to the total unit weight

ACOUSTIC DATA

MODEL		012 M1 S	018 M1 S	022 M1 S	030 M1 S	047 M1 S
SIZE		E1	E2	E3	E4L	E5L
SOUND LEVEL ISO 3744 (1)						
On air delivery, Under	dB(A)	64,0	71,4	68,0	74,8	81,5
On air intake, Under	dB(A)	52,7	54,2	51,1	57,9	66,1
On front side, Under	dB(A)	46,0	47,6	44,5	51,1	59,4
Air flow (2)	m ³ /h	2700	4100	5100	7500	12000

MODEL		042 M2 D	068 M2 D	094 M2 D	120 M4 D	150 M4 D
SIZE		E5L	E7L	E8L	E9L	E9L
SOUND LEVEL ISO 3744 (1)						
On air delivery, Under	dB(A)	81,5	77,2	82,5	83,4	83,4
On air intake, Under	dB(A)	66,1	61,9	67,1	68,1	68,1
On front side, Under	dB(A)	59,4	55,2	60,4	61,5	61,5
Air flow (2)	m ³ /h	12000	17500	22000	32000	32000

1. Noise pressure level at 1 meter in free field – ISO 3744
2. Nominal air flow with noise absorption partitions plenum installation and external static pressure 20 Pa



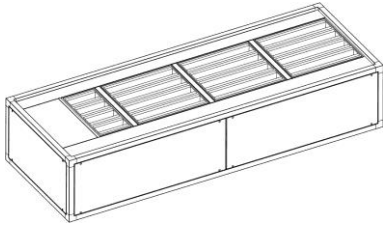

PLENUM ON AIR DELIVERY WITH HIGH EFFICIENCY FILTERS

The plenum must be installed on air delivery.
 The plenum is fitted with high efficiency rigid bag filters.
 Filters are made of glass micro fibre and are not regenerable.
 Remove the frontal panels for filters replacement.

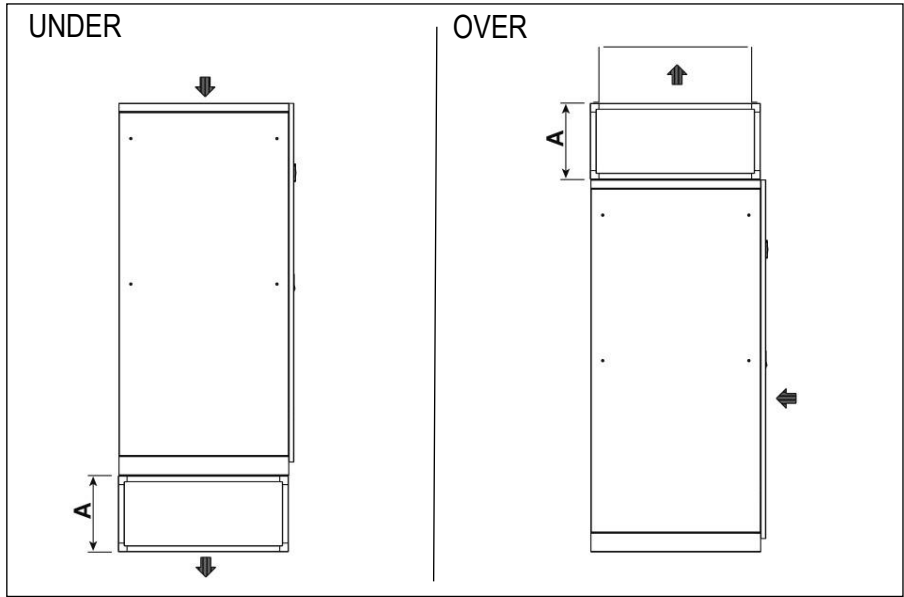

MODEL		012 M1 S	018 M1 S	022 M1 S	030 M1 S	047 M1 S
SIZE		E1	E2	E3	E4L	E5L
VERSIONE (1)		U / O	U / O	U / O	U / O	U / O
A	mm	490	490	490	510	510
Weight (2)	kg	26	27	30	55	60
PRESSURE DROPS (3)						
Filters ePM _{2.5} 50%	Pa	58	113	64	45	81
Filters ePM _{2.5} 50%	Pa	72	115	79	55	99
Filters ePM _{2.5} 50%	Pa	86	138	97	67	121

MODEL		042 M2 D	068 M2 D	094 M2 D	120 M4 D	150 M4 D
SIZE		E5L	E7L	E8L	E9L	E9L
VERSIONE (1)		U / O	U / O	U / O	U	U
A	mm	510	510	510	510	510
Weight (2)	kg	60	90	100	110	110
PRESSURE DROPS (3)						
Filters ePM _{2.5} 50%	Pa	81	86	116	172	172
Filters ePM _{2.5} 50%	Pa	99	105	118	210	210
Filters ePM _{2.5} 50%	Pa	121	128	144	255	255

1. U = Under, downflow / O = Over, upflow
2. Add this value to the total unit weight
3. Data referred to the nominal air flow and clean filters. Value to be subtracted from the maximum external static pressure of the unit.



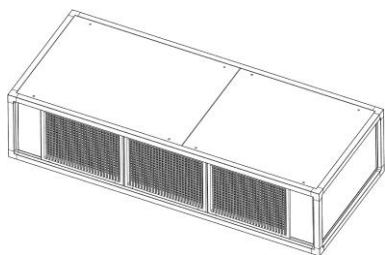

PLENUM ON AIR DELIVERY WITH FRONTAL GRILLE

The plenum allows the frontal air distribution directly into the room.

The plenum is supplied with air distribution grille with double row adjustable grilles on front side.

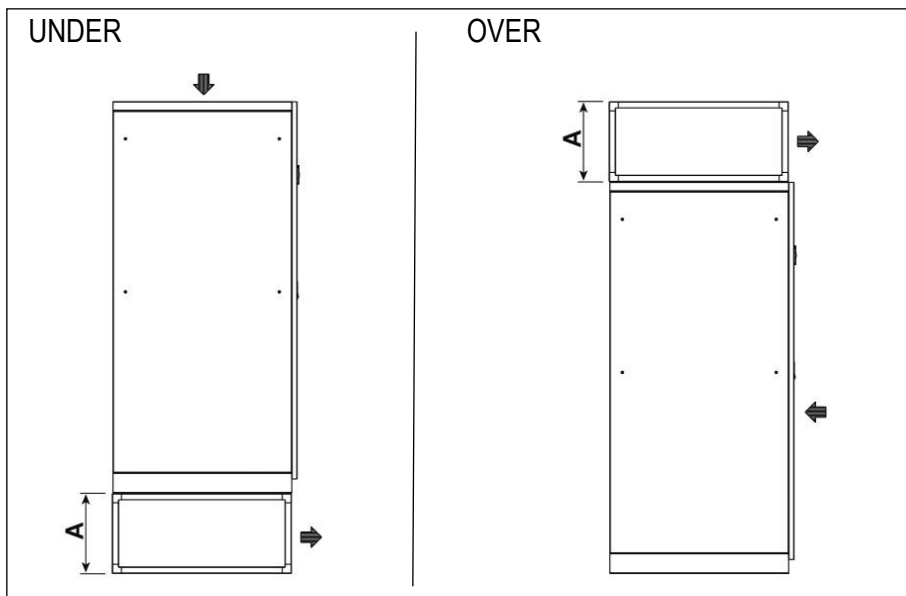

SIZE		E1	E2	E3	E4L	E5L	E7L	E8L	E9L
VERSION (1)		U / O	U / O	U / O	U / O	U / O	U / O	U / O	U
A	mm	490	490	490	510	510	510	510	510
Weight (2)	kg	23	26	28	50	55	90	110	130

PLENUM ON AIR DELIVERY WITH FRONTAL GRILLE REACTION TO FIRE - EUROCLASS A1

SIZE		E1	E2	E3	E4L	E5L	E7L	E8L	E9L
VERSION (1)		U / O	U / O	U / O	U / O	U / O	U / O	U / O	U
A	mm	490	490	490	510	510	510	510	510
Weight (2)	kg	29	32	36	63	70	108	130	152

1. U = Under, downflow / O = Over, upflow
2. Add this value to the total unit weight

PLENUM ON AIR DELIVERY WITH FRONTAL AND LATERAL GRILLES

The plenum allows the air distribution directly into the room.

The plenum is supplied with air distribution grilles with double row adjustable grilles on front and lateral side.

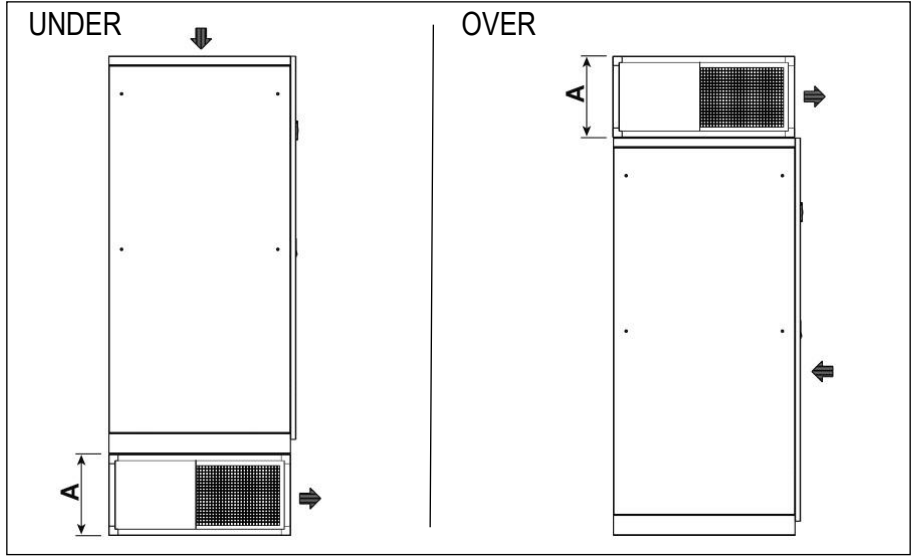
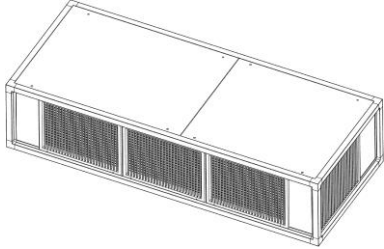

SIZE		E1	E2	E3	E4L	E5L	E7L	E8L	E9L
VERSION (1)		U / O	U / O	U / O	U / O	U / O	U / O	U / O	U
A	mm	490	490	490	510	510	510	510	510
Weight (1)	kg	21	23	30	50	55	90	100	120

**PLENUM ON AIR DELIVERY WITH FRONTAL AND LATERAL GRILLES
REACTION TO FIRE – EUROCLASS A1**

SIZE		E1	E2	E3	E4L	E5L	E7L	E8L	E9L
VERSION (1)		U / O	U / O	U / O	U / O	U / O	U / O	U / O	U
A	mm	490	490	490	510	510	510	510	510
Weight (1)	kg	25	28	37	61	68	106	118	140

1. U = Under, downflow / O = Over, upflow
2. Add this value to the total unit weight

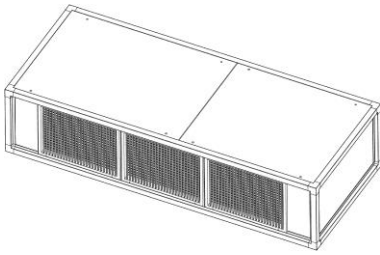

PLENUM ON AIR DELIVERY WITH FRONTAL GRILLE AND NOISE ABSORPTION PARTITIONS

The optional is not available for Under version.

The plenum allows the frontal air distribution directly into the room and a noise reduction of the air delivery.

The plenum is supplied with air distribution grille with double row adjustable grilles on front side and noise absorption partitions,

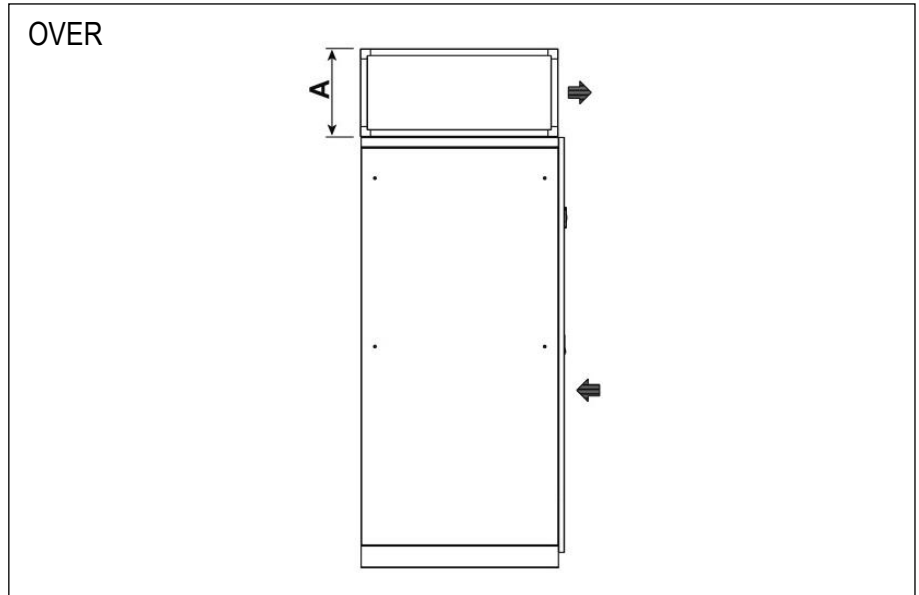

MODEL		012 M1 S	018 M1 S	022 M1 S	030 M1 S	047 M1 S
SIZE		E1	E2	E3	E4L	E5L
A	mm	490	490	490	510	510
Weight (1)	kg	30	30	37	72	77
SOUND LEVEL ISO 3744 (2)						
On air delivery, Over	dB(A)	60,0	62,1	61,2	65,9	76,4
On air intake, Over (3)	dB(A)	53,4	48,7	48,9	52,2	63,3
Irradiated, Over (4)	dB(A)	46,1	43,1	42,4	47,1	59,2
ADDITIONAL PRESSURE DROPS (5)	Pa	52	83	50	52	84
AIR FLOW	m ³ /h	2700	4100	5100	7500	12000

MODEL		042 M2 D	068 M2 D	094 M2 D
SIZE		E5L	E7L	E8L
A	mm	510	510	510
Weight (1)	kg	77	110	110
SOUND LEVEL ISO 3744 (2)				
On air delivery, Over	dB(A)	76,4	72,5	77,3
On air intake, Over (3)	dB(A)	63,3	59,6	64,4
Irradiated, Over (4)	dB(A)	59,2	55,3	60,1
ADDITIONAL PRESSURE DROPS (5)	Pa	84	102	120
AIR FLOW	m ³ /h	12000	17500	22000

1. Add this value to the total unit weight
2. Noise pressure level at 1 meter in free field – ISO 3744
3. Air intake from the front
4. Air intake from the bottom
5. Value to be subtracted from the nominal external static pressure of the unit



OPTIONAL ACCESSORIES – DIRECT FREE-COOLING PLENUM

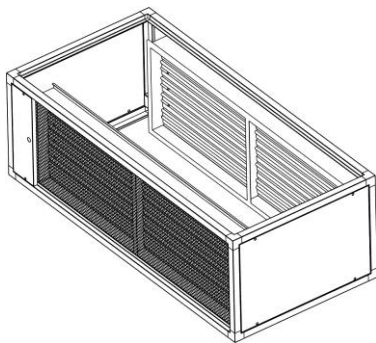
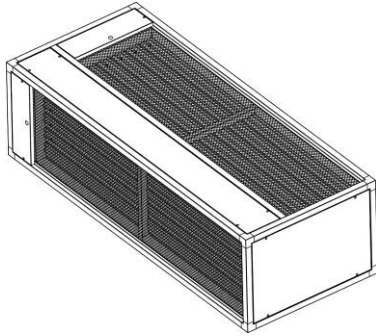

The optional is supplied separately and the installation on the unit is at Customer care. The plenums have same technical characteristics and base dimensions of the machine cabinet. The optional allow to obtain free-cooling by direct ambient air intake into the room. The dampers are proportionally managed by the microprocessor control, that regulates the quantity of the ambient air to put in the room according to the set-point.

COMPONENTS

- Frame in aluminium extrusion, painted with epoxy powders. Colour RAL 9005;
- Panels in galvanized steel sheet with protective surfaces treatment in compliance with UNI ISO 9227/ASTMB117 and ISO 7253, and painted with epoxy powders. Colour RAL 9005;
- Panels insulated with polyurethane foam and seals to ensure air tight.
- Panels fixed with screws.
- Removable panels.
- Opposed blade dampers in galvanized steel sheet and safety grille for ambient air and room air suction.
- Actuator for each damper.
- Terminals for electric connection to the unit.
- Combined Temperature / Humidity sensor on machine air suction. The sensor must be moved outside the air conditioners for a proper read of the room temperature value.
- Temperature sensor for outdoor air. The sensor must be installed in the outdoor air suction duct or anyway protected against atmospheric agent.
- Free contact for free-cooling operating status monitoring.
- Set of fixing elements to fasten the plenum to the unit.

For a correct installation use a gasket between the plenum and the unit.

WARNING

IT IS COMPULSORY TO INSTALL INTO THE ROOM AN APPROPRIATELY SIZED OVERPRESSURE DAMPER TO ALLOW THE ROOM AIR EXHAUSTION DURING FREE-COOLING WORKING MODE.

INSTALLATION EXAMPLE

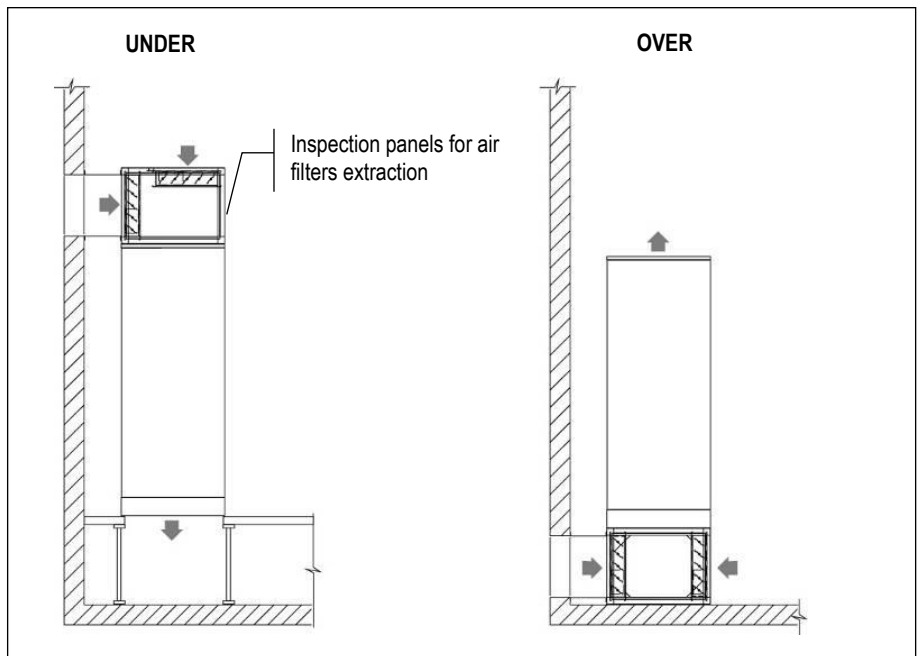

Ducting are at Customer care. We suggest you to install a rain-proof grille on ambient air intake.

OVER VERSION

SIZE E1 / E2 / E3

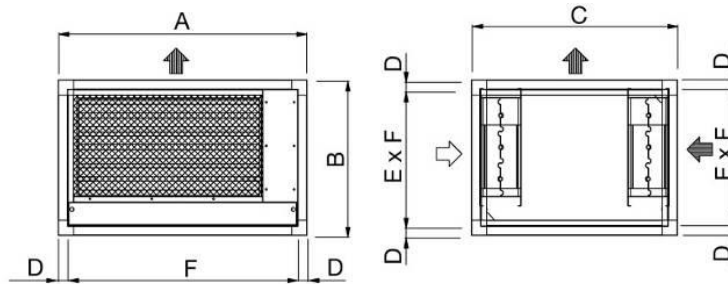

SIZE E4L / E5L

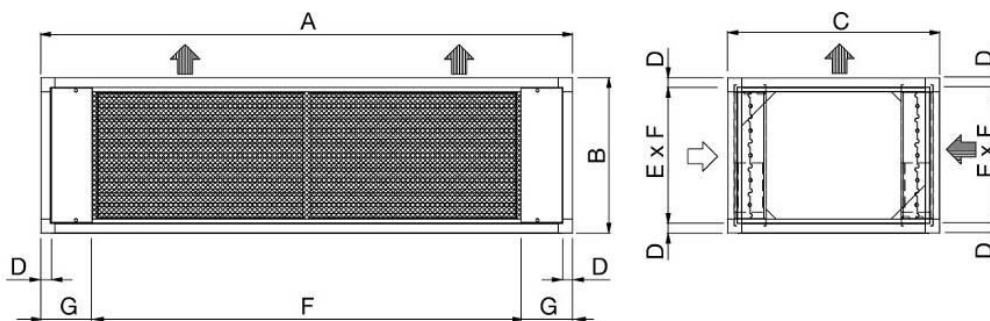

SIZE E6L / E7L / E8L

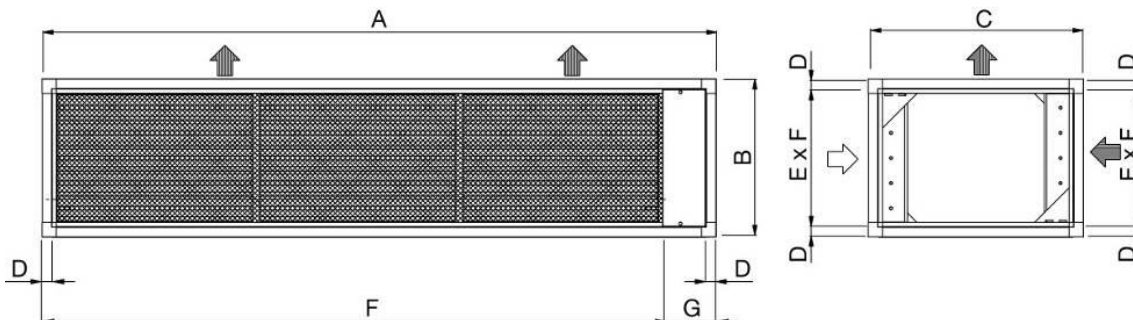

SIZE		E1	E2	E3	E4L	E5L	E7L	E8L	E9L
A	mm	650	785	1085	1630	1955	2499	2899	--
B	mm	490	490	490	630	630	630	630	--
C	mm	650	650	750	905	905	905	905	--
D	mm	30	30	30	40	40	40	40	--
E	mm	430	430	430	550	550	550	550	--
F	mm	590	725	1025	1335	1335	1965	2220	--
G	mm	--	--	--	147,5	472,5	534	679	--
Weight (1)	kg	24	27	35	147,5	147,5	--	--	--

1. Add this value to the total unit weight

UNDER VERSION

SIZE E1 / E2 / E3

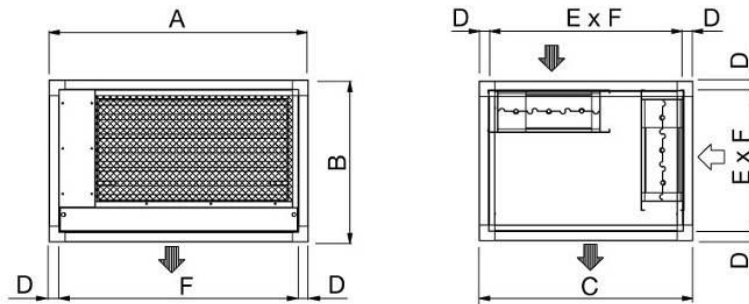

SIZE E4L / E5L

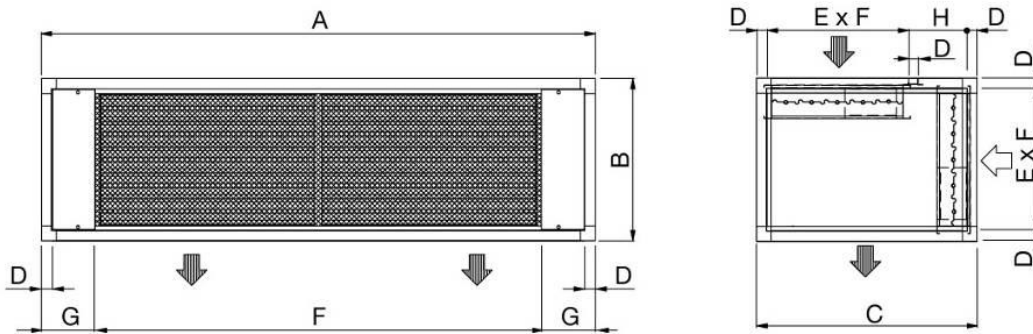

SIZE E6L / E7L / E8L / E9L

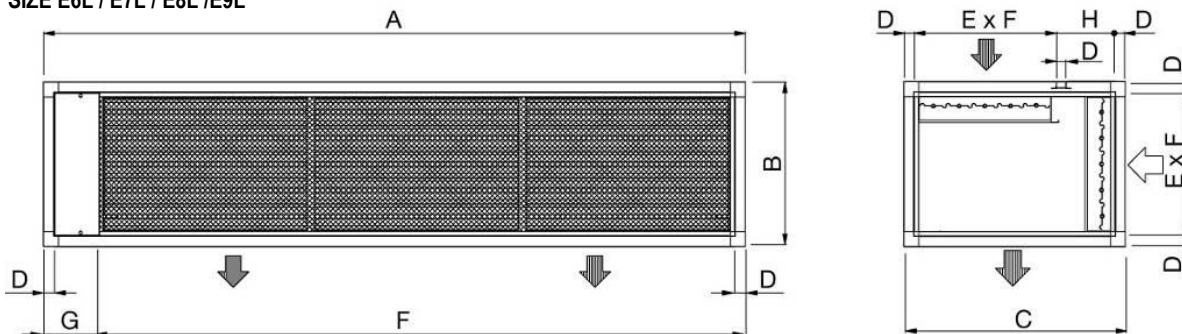

SIZE		E1	E2	E3	E4L	E5L	E7L	E8L	E9L
A	mm	650	785	1085	1630	1955	2499	2899	3299
B	mm	490	490	490	630	630	630	630	630
C	mm	650	650	750	905	905	905	905	905
D	mm	30	30	30	40	40	40	40	40
E	mm	430	430	430	550	550	550	550	550
F	mm	590	725	1025	1335	1335	1965	2220	2375
G	mm	--	--	--	147,5	472,5	534	679	924
H	mm	--	--	--	147,5	147,5	--	--	--
Weight (1)	kg	24	27	35	61	66	110	130	150

1. Add this value to the total unit weight

OPTIONAL ACCESSORIES – BOTTOM PANEL FOR OVER VERSION

Available for OVER units.

With this accessory, it is possible a noise insulation of the machine base, when the machine is installed directly on particular floor as raised floor, wood floor etc.

The accessory includes:

- Panel in galvanized steel sheet.
- Noise insulation with special soundproof material.

The bottom panel is supplied assembled inside the unit base and does not modify the unit dimensions.

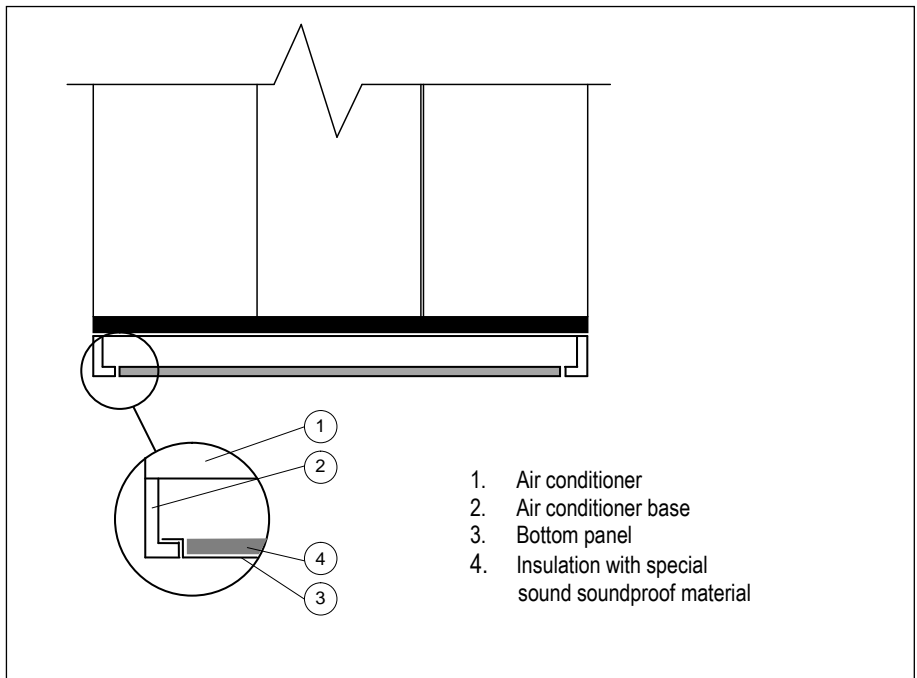

OPTIONAL ACCESSORIES – KIPlink – Keyboard in your Pocket



KIPlink - Keyboard In Your Pocket - is the innovative user interface based on WiFi technology that allows one to operate on the unit directly from the smartphone or tablet. Using KIPlink, it is possible to turn the unit on and off, adjust the set-point, plot the main operating variables, monitor in detail the status of the refrigerant circuits, the compressors, the fans and display and reset the possible alarms.

Scan the QR code on the electrical board of the unit to have access to the unit control through web browser web or App. The access is possible within the local WiFi network.

KIPlink hardware:

- Wi-Fi antenna in the electrical board;
- ON/OFF button with power LED and Unit status LED. Provided when the unit is equipped with KIPlink and without 6-keys keyboard (optional).

KIPlink allows;

- Easy and enhanced unit management
- Real-Time graphs and key trends
- Different information for each kind of user

OPTIONAL ACCESSORIES – CLOUD PLATFORM: WEB SERVICES BASED ON CLOUD TECHNOLOGY FOR REMOTE MONITORING AND MANAGEMENT OF AIR CONDITIONING PLANTS.



CLOUD PLATFORM is an ecosystem of web services for remote monitoring and management of air conditioning plants; specifically designed for mobile usage on tablets and smartphones, it allows to access plant data everywhere on the go so saving time, money and delivering a higher service level to the customer.

TECHNOLOGY

Based on cloud technology it allows, through machines data telemetry, to monitor and control units on the field, process data and perform proactive maintenance.

The hardware heart of the system is the Cloud box that can collect plant data (up to 31 devices and up to 1000 registers).

Connectivity between monitored devices and Cloud box may be wired in Ethernet, RS485, RS232 and must be in MODBUS protocol.

Cloud Platform then send these data to dedicated server in cloud in through the mobile (GPRS or 3G) network or ADSL.

Information security; each communication channel can be encrypted in VPN, ensuring data privacy.

USER SIDE

Cloud Platform is designed for mobile communication. So, the user just need a tablet or a smartphone to access the RC Cloud Platform and check his plant.

Cloud Platform App is available both on Android and iOS operating systems so the environment may be accessed directly from them beyond company site and platform site. Access through pc is available too.

FUNCTIONS

Telemetry & Data Export

Data polling and history of all data (1 year).
Export diagram and table (csv). **Your data always on the go.**

Multi Device

Many type of devices can be connected to the same box (chillers, close control, energy meters, flow meters, pumps,...).
Only a request: MODBUS protocol. Electrical connection in Ethernet, RS 485 or RS 232.

Multi Language

English native, Cloud Platform language pack is available for the main markets.

Virtual Display

Monitoring and control (on/off, alerts reset, main parameters change) as being beside the unit, in an augmented reality way.

Designed for Mobile.

Same as standing in front of the unit, when in your office or in any other place.

Internet Connectivity

ETHERNET + GPRS + 3G connection capability on Public and Virtual Private Network (VPN).

Alerts Warning through:

- Push notification
- e-mail
- Voice calls
- SMS

Processing of specialized plant KPI to get:

- Energy performance (gross instant EER)
- Components Failure Forecast (coming soon)
- Unit diagnosis

MACHINE DRAWINGS
Dimensions in mm – UNDER E1

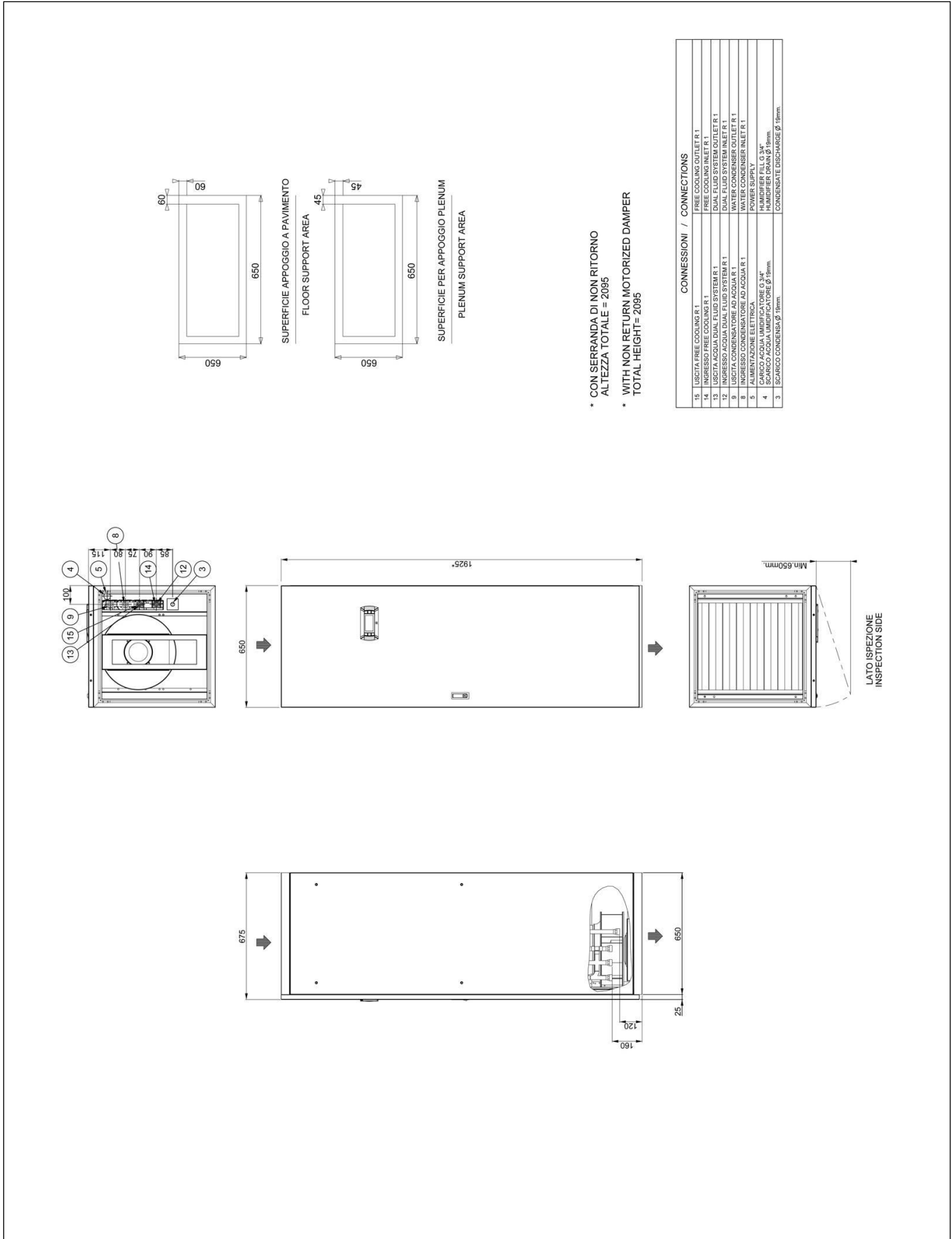

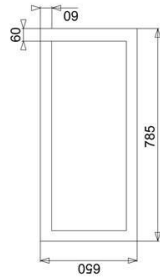
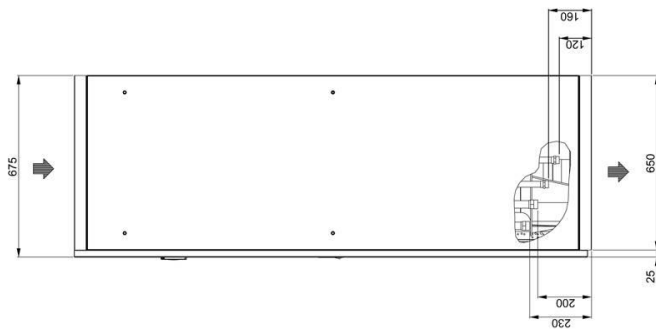
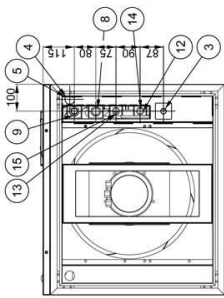

SUPERFICIE APPOGGIO A PAVIMENTO
FLOOR SUPPORT AREA

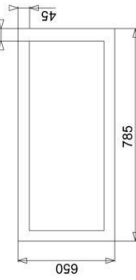

SUPERFICIE PER APPOGGIO PLENUM
PLENUM SUPPORT AREA

* CON SERRANDA DI NON RITORNO
ALTEZZA TOTALE = 2095

* WITH NON RETURN MOTORIZED DAMPER
TOTAL HEIGHT = 2095

CONNESSIONI / CONNECTIONS	
15	USCITA FREE COOLING R 1
14	INGRESSO R 1
13	USCITA ACQUA DUAL FLUID SYSTEM R 1
12	INGRESSO ACQUA DUAL FLUID SYSTEM R 1
11	USCITA ACQUA DUAL FLUID SYSTEM OUTLET R 1
10	INGRESSO ACQUA DUAL FLUID SYSTEM INLET R 1
9	USCITA CONDENSATORE AD ACQUA R 1
8	INGRESSO CONDENSATORE AD ACQUA R 1
7	USCITA CONDENSATORE AD ACQUA R 1
6	INGRESSO CONDENSATORE AD ACQUA R 1
5	ALIMENTAZIONE ELETTRICA
4	SCARICO ACQUA UMIDIFICATORE Ø 18mm
3	SCARICO CONDENSATA Ø 18mm

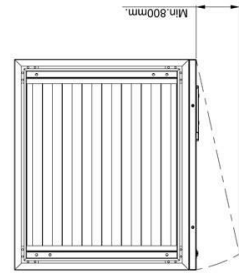

LATO ISPEZIONE
INSPECTION SIDE

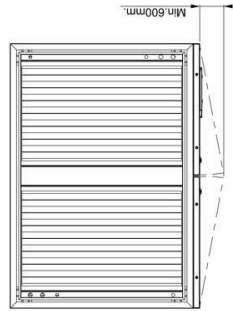
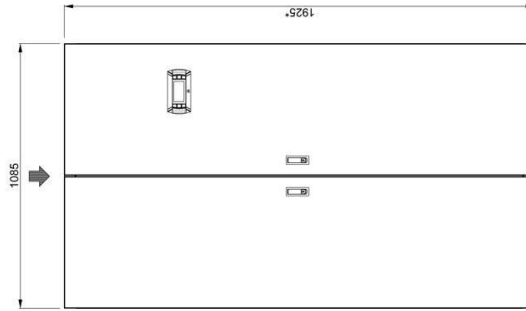
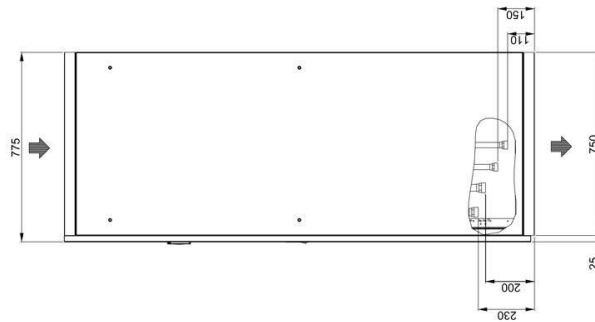
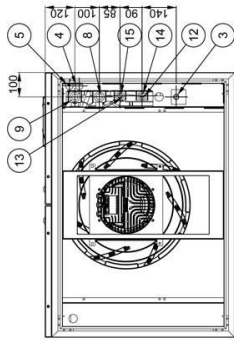

LATO ISPEZIONE
INSPECTION SIDE

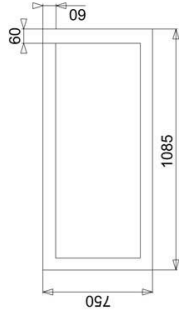

SUPERFICIE APPOGGIO A PAVIMENTO
FLOOR SUPPORT AREA

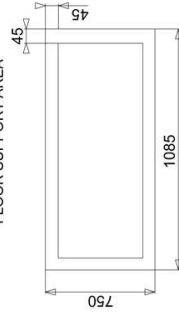

SUPERFICIE PER APPOGGIO PLENUM
PLENUM SUPPORT AREA

- * CON SERRANDA DI NON RITORNO
ALTEZZA TOTALE = 2095
- * WITH NON RETURN MOTORIZED DAMPER
TOTAL HEIGHT= 2095

CONNESSIONI / CONNECTIONS	
15	USCITA FREE COOLING R. 1/4
14	INGRESSO FREE COOLING R. 1/4
13	USCITA ACQUA DUAL FLUID SYSTEM R. 1/4
12	INGRESSO ACQUA DUAL FLUID SYSTEM R. 1/4
9	USCITA CONDENSATORE AD ACQUA R. 1/4
8	INGRESSO CONDENSATORE AD ACQUA R. 1/4
5	ALIMENTAZIONE ELETTRICA
4	SCARICO ACQUA UMIDIFICATORE Ø 3/4"
3	SCARICO CONDENSATE Ø 18mm.
	CONDENSATE DISCHARGE Ø 18mm.
	POWER SUPPLY Ø 3/4"
	WATER CONDENSER INLET R. 1/4
	WATER CONDENSER OUTLET R. 1/4
	DUAL FLUID SYSTEM INLET R. 1/4
	DUAL FLUID SYSTEM OUTLET R. 1/4
	FREE COOLING INLET R. 1/4
	FREE COOLING OUTLET R. 1/4

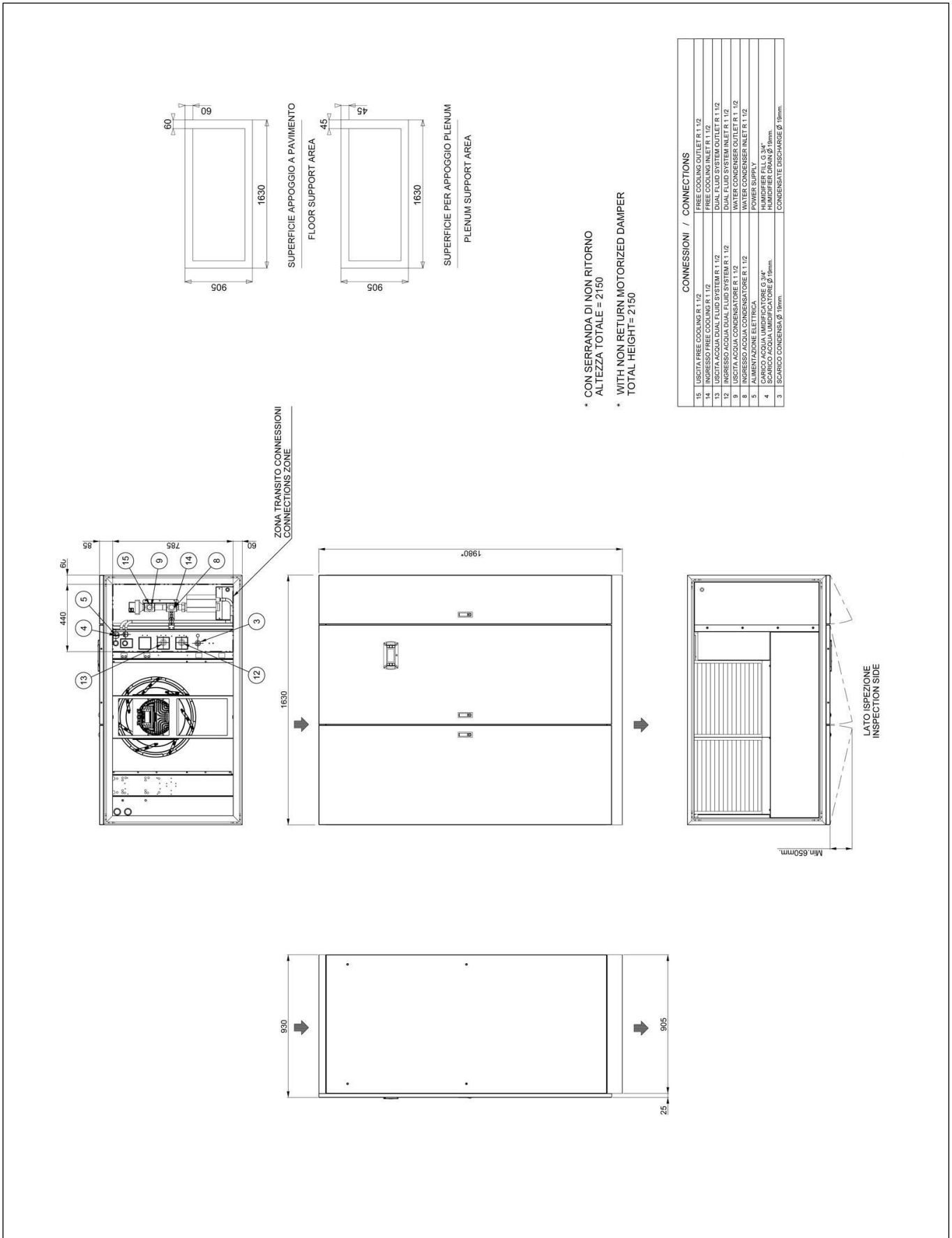

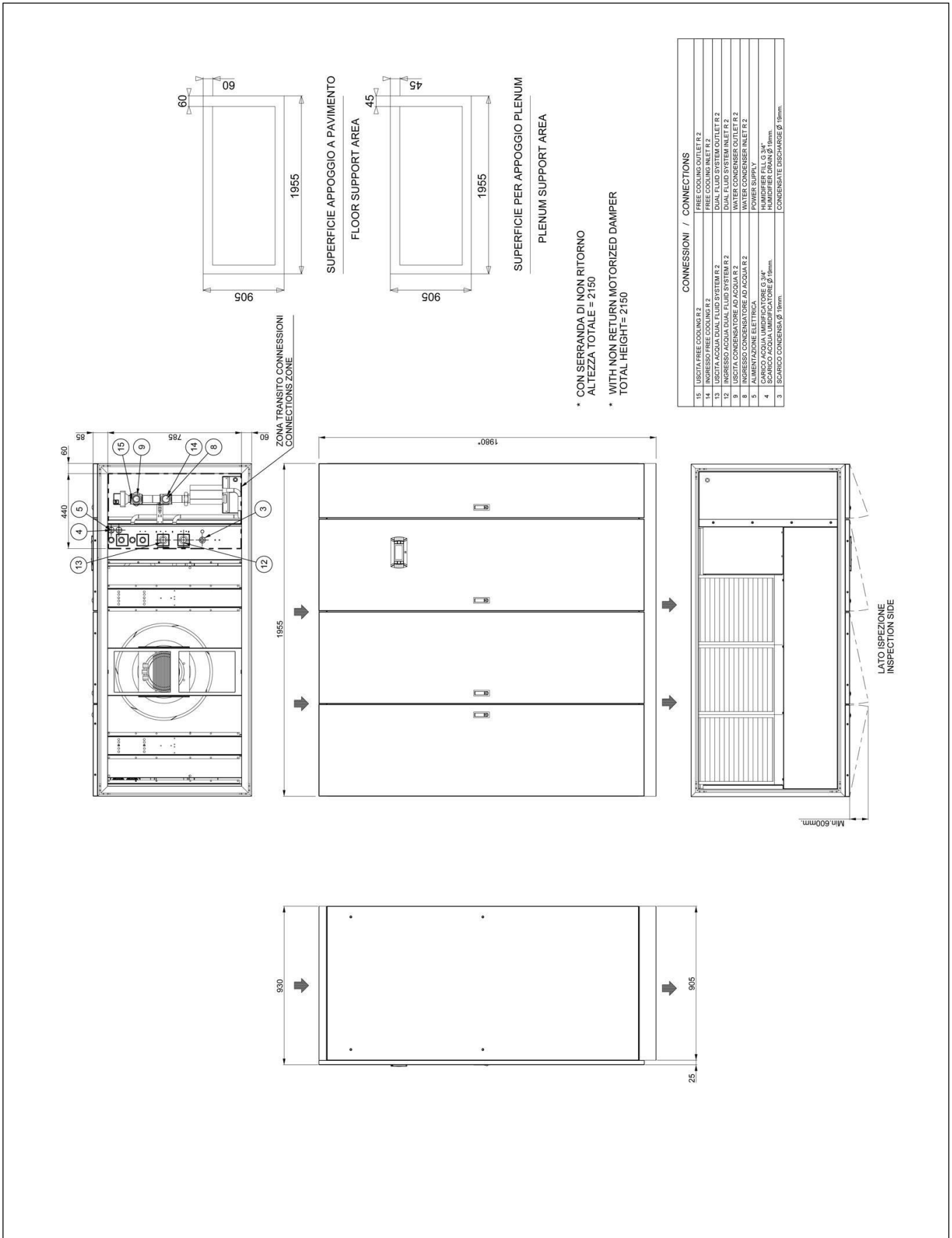

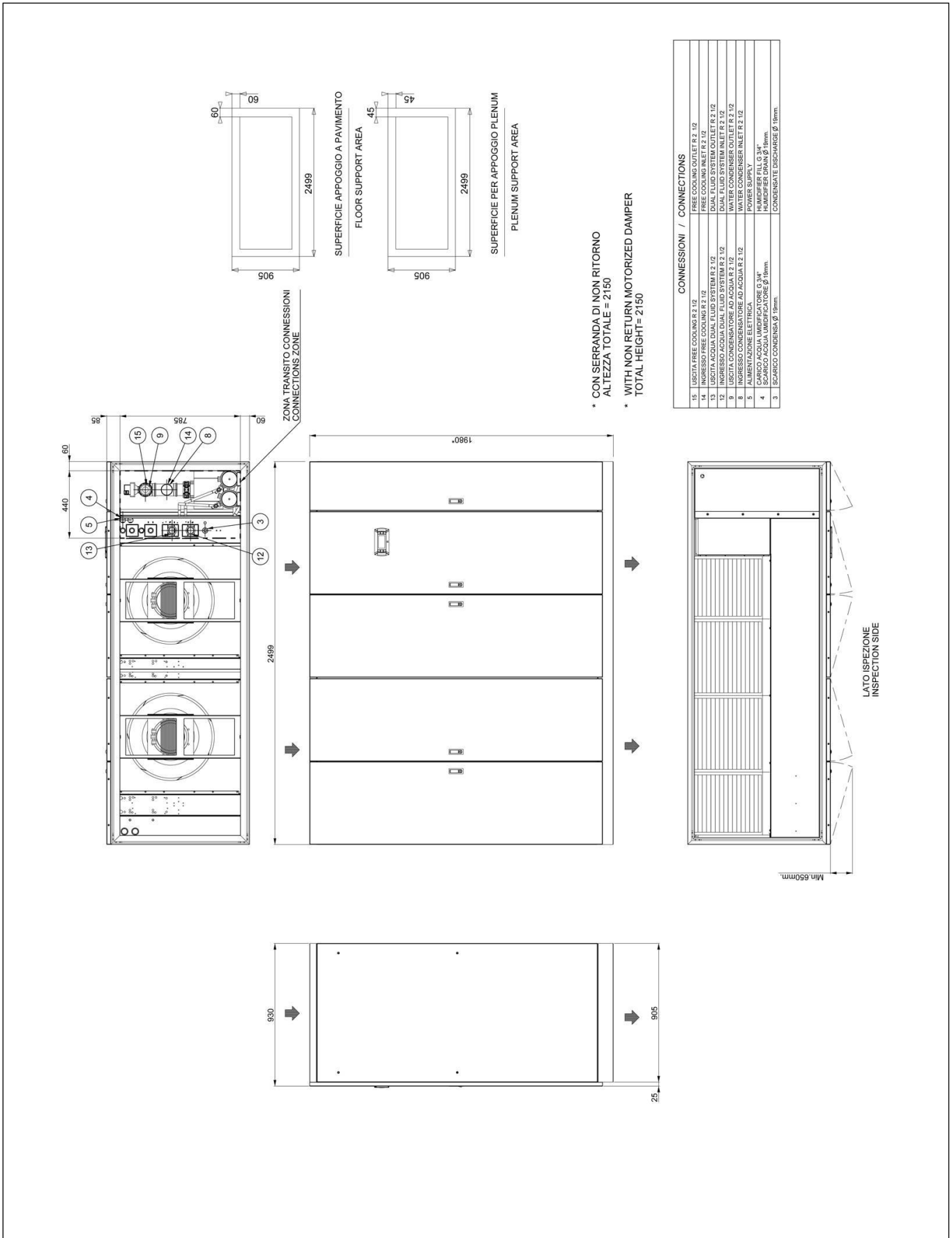

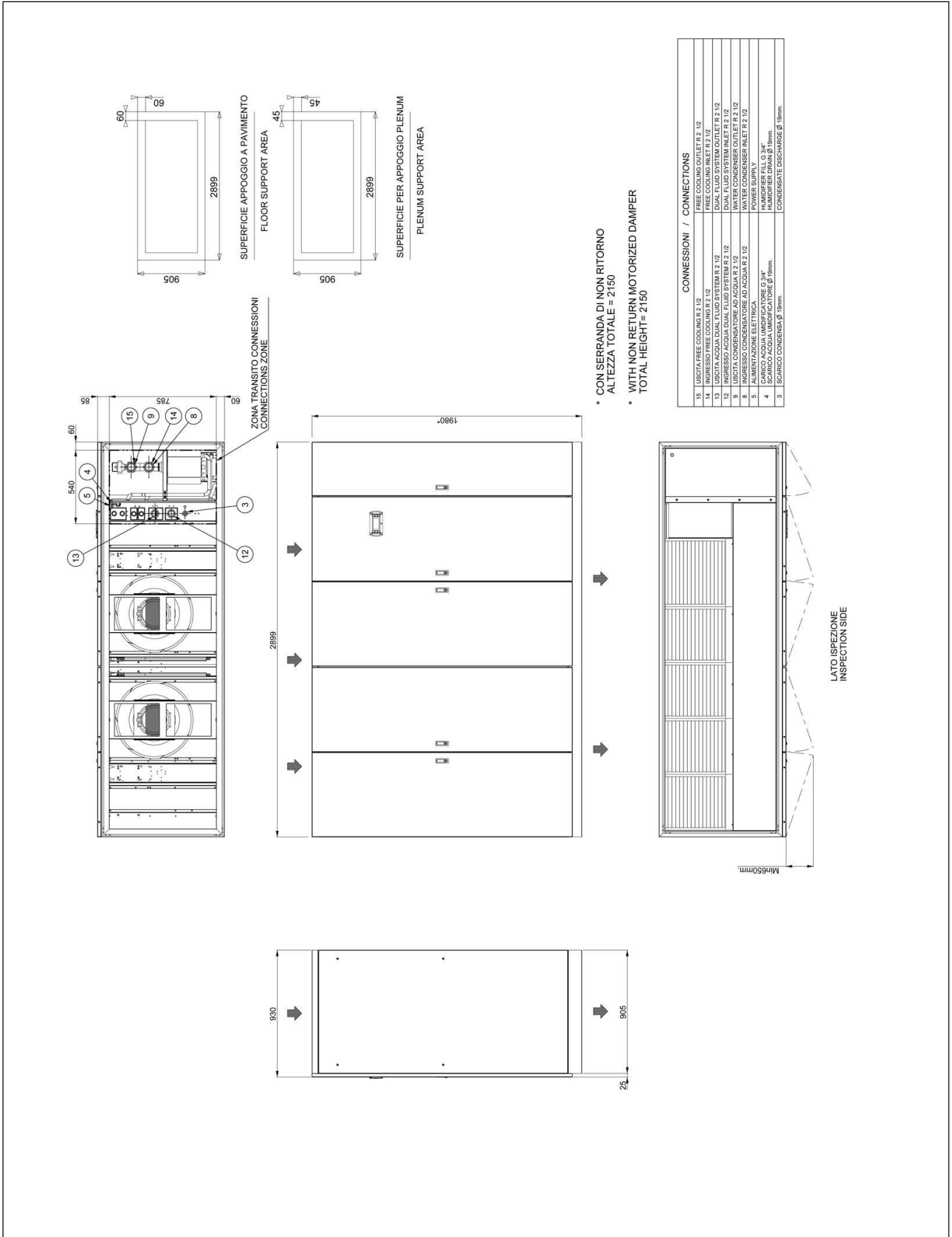

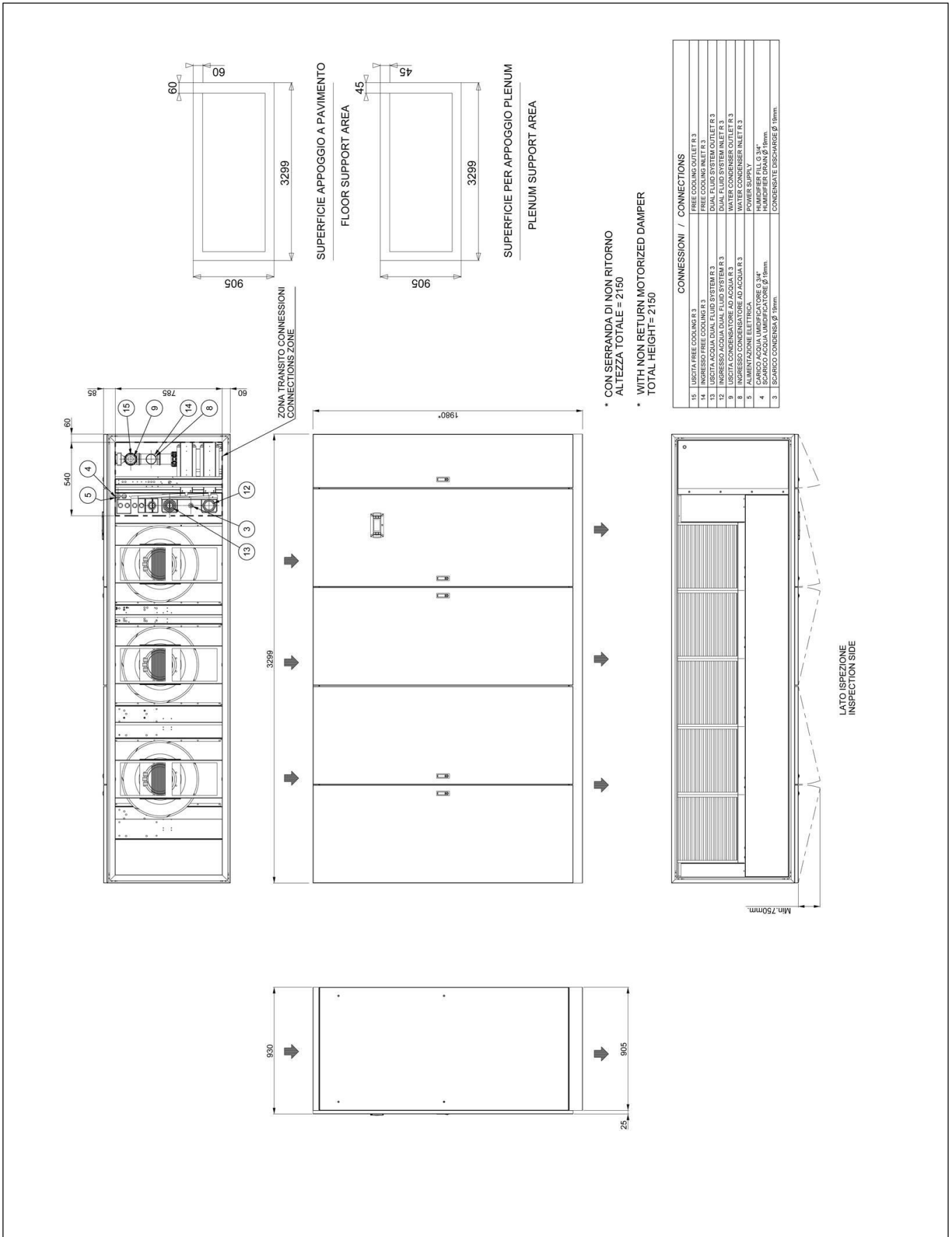

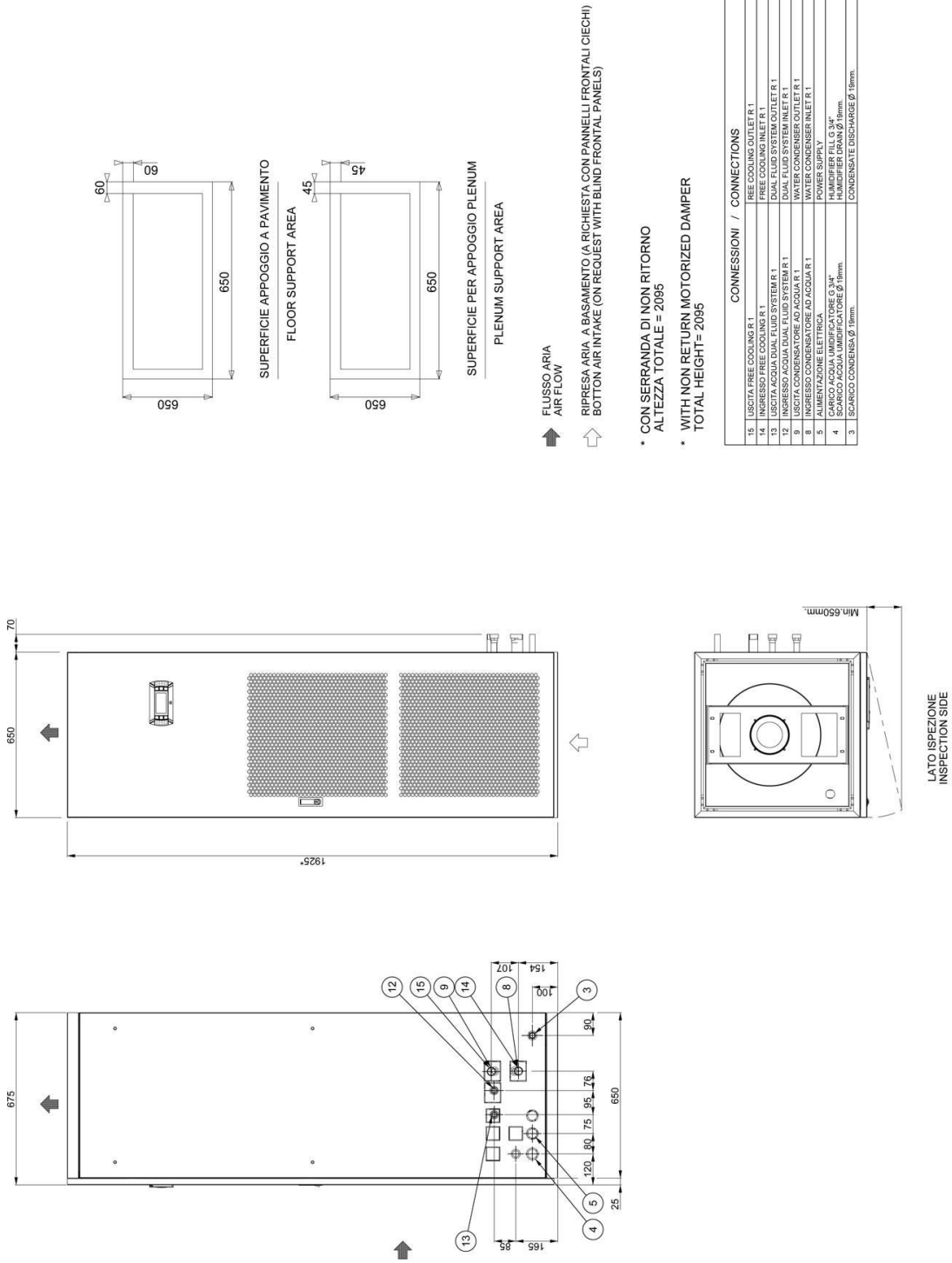

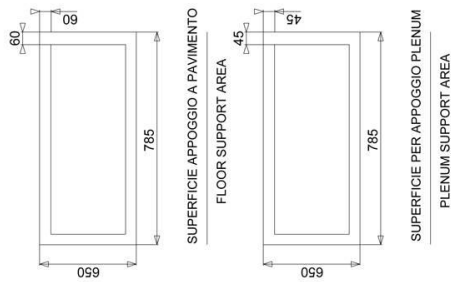
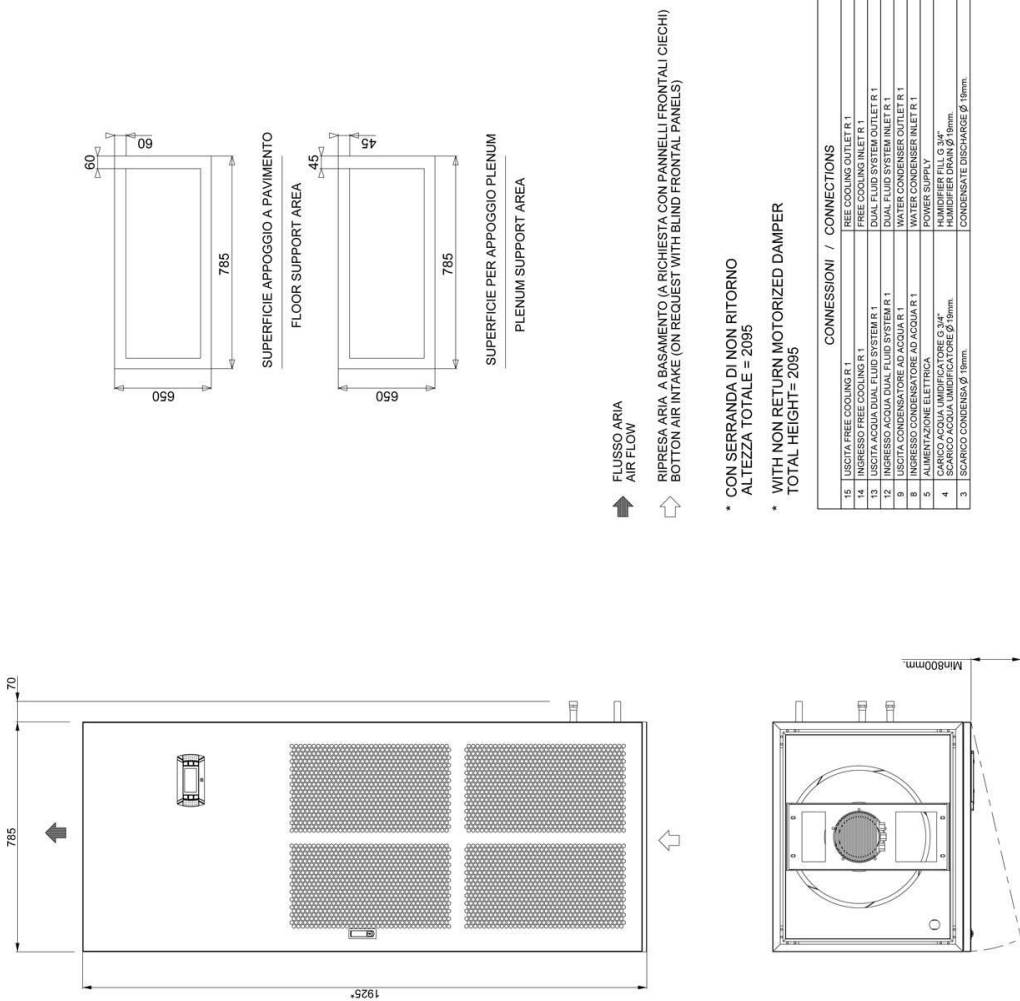

↑ FLUSSO ARIA
AIR FLOW

↑ RIPRESA ARIA A BASAMENTO (A RICHIESTA CON PANNELLI FRONTALI CIECHI)
BOTTOM AIR INTAKE (ON REQUEST WITH BLIND FRONTAL PANELS)

* CON SERRANDA DI NON RITORNO
ALTEZZA TOTALE = 2095

* WITH NON RETURN MOTORIZED DAMPER
TOTAL HEIGHT = 2095

CONNESSIONI / CONNECTIONS	
15	USCITA PERE COOLING R.1
14	INGRESSO ACQUA R.1
13	USCITA ACQUA DUAL FLUID SYSTEM R.1
12	INGRESSO ACQUA DUAL FLUID SYSTEM R.1
9	USCITA CONDENSATORE AD ACQUA R.1
8	INGRESSO CONDENSATORE AD ACQUA R.1
5	ALIMENTAZIONE ELETTRICA
4	SCARICO ACQUA UMIDIFICATORE Ø 3/4"
3	SCARICO CONDENSATA Ø 19mm.
	CONDENSATE DISCHARGE Ø 19mm.

LATO ISPEZIONE
INSPECTION SIDE

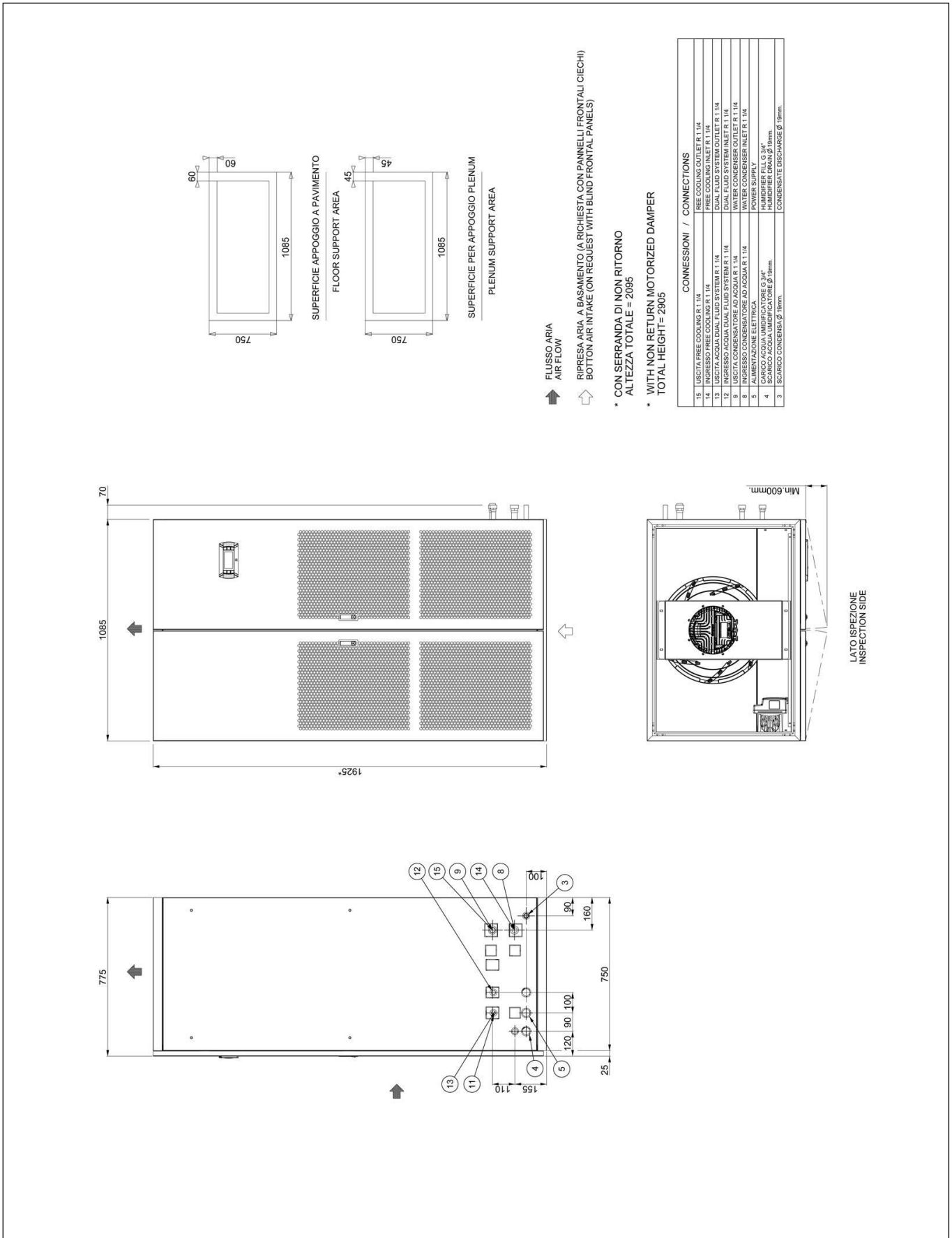

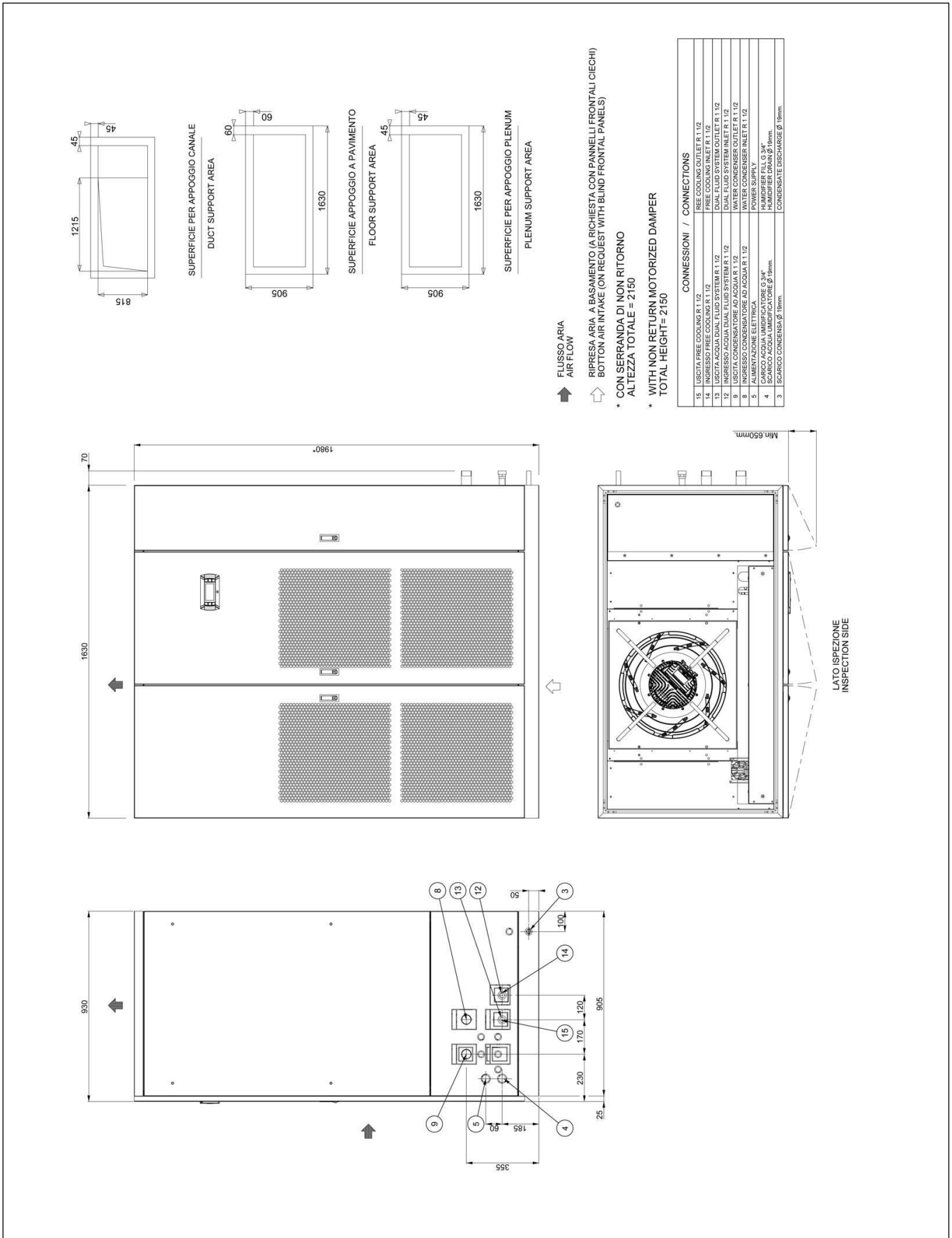

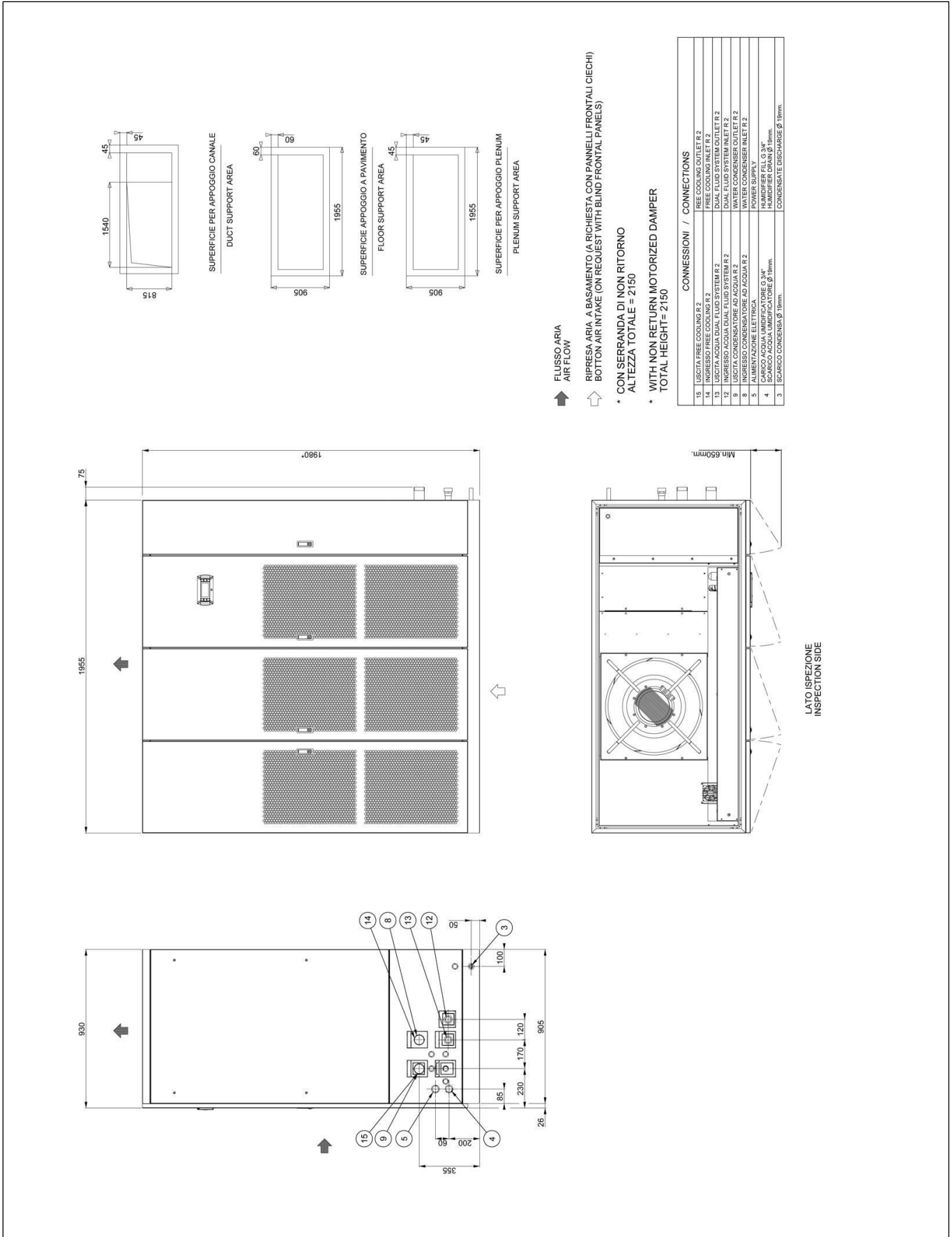

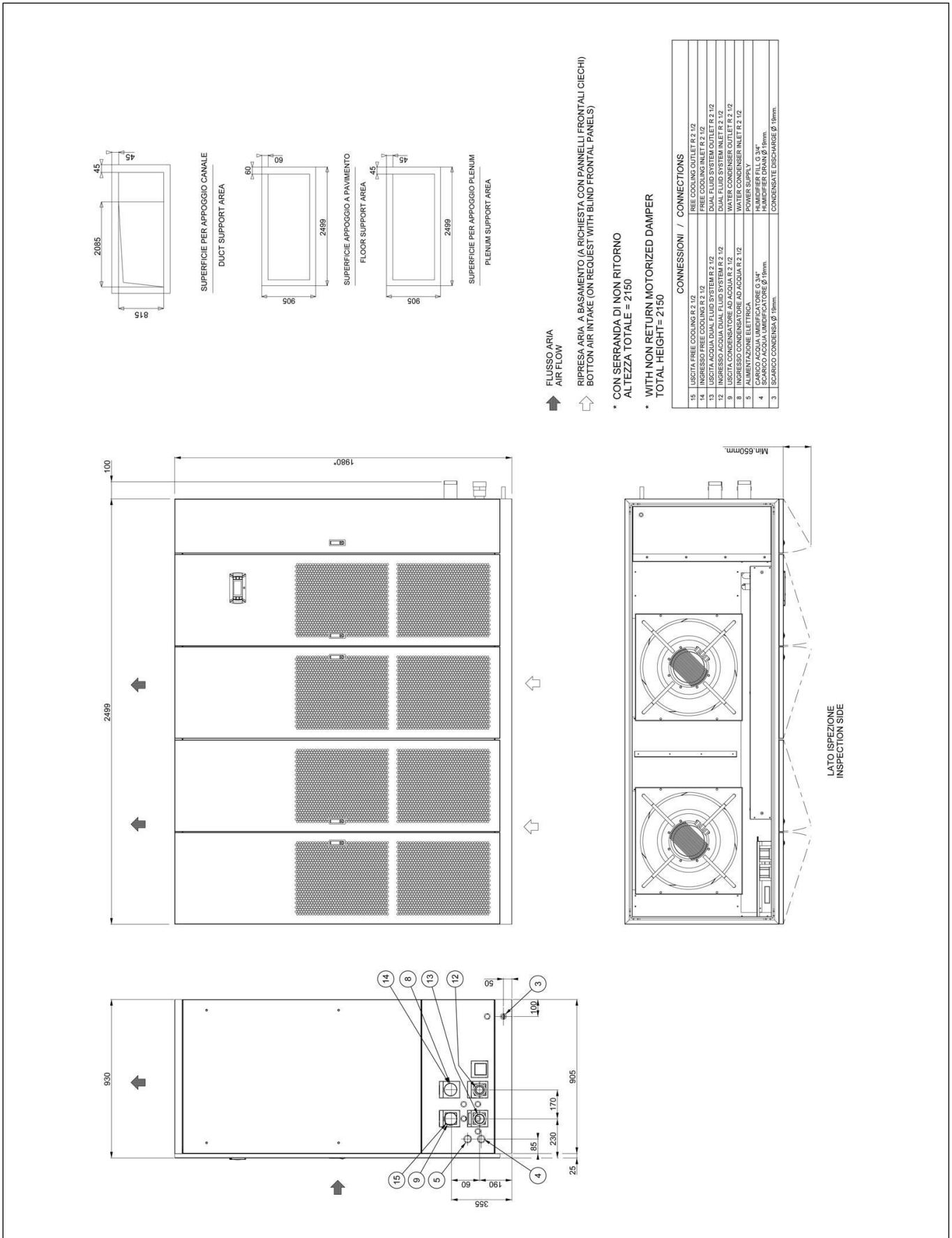

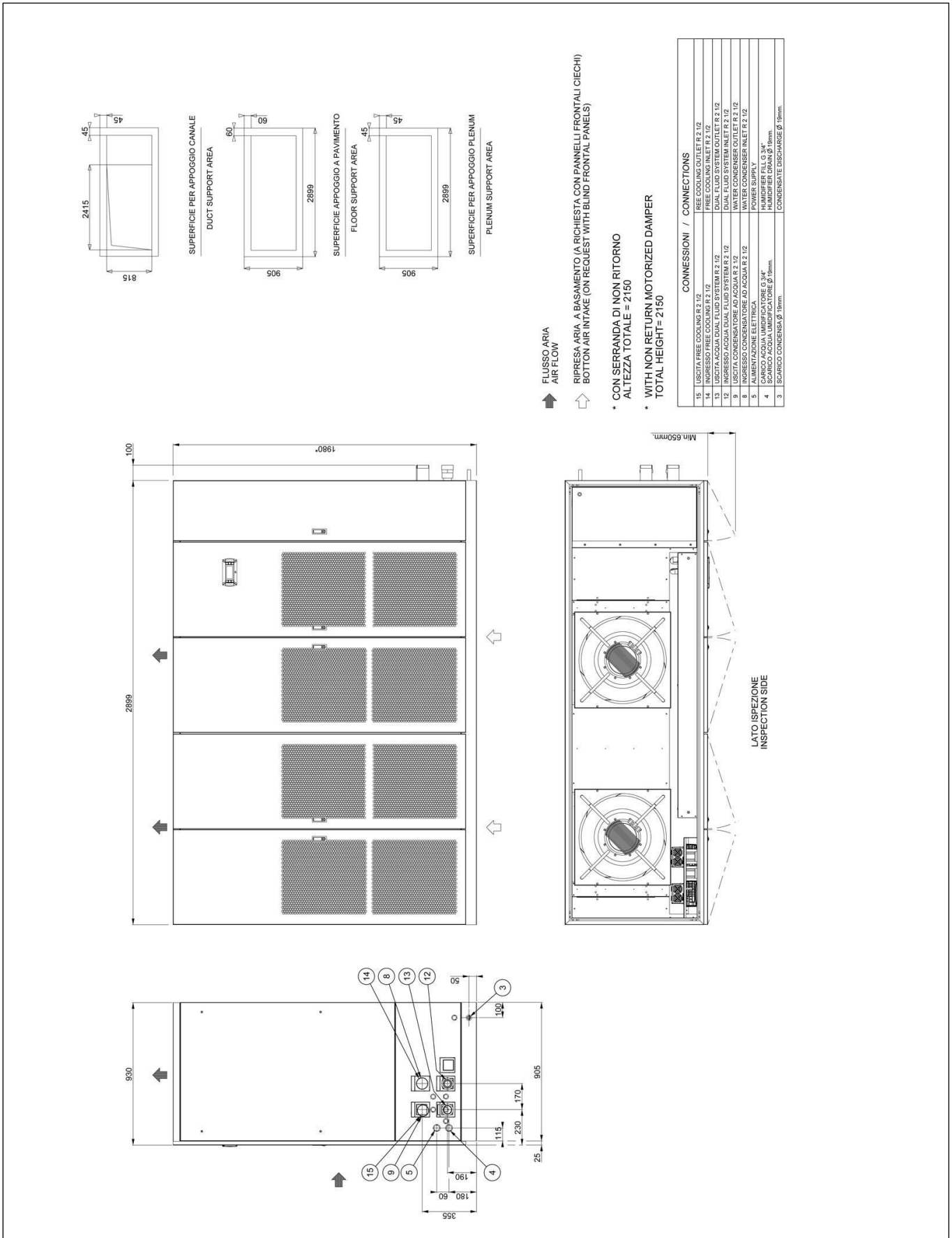

HOLE IN THE RAISED FLOOR FOR DOWNFLOW VERSION

HOLE IN THE RAISED FLOOR WITHOUT FLOOR STAND

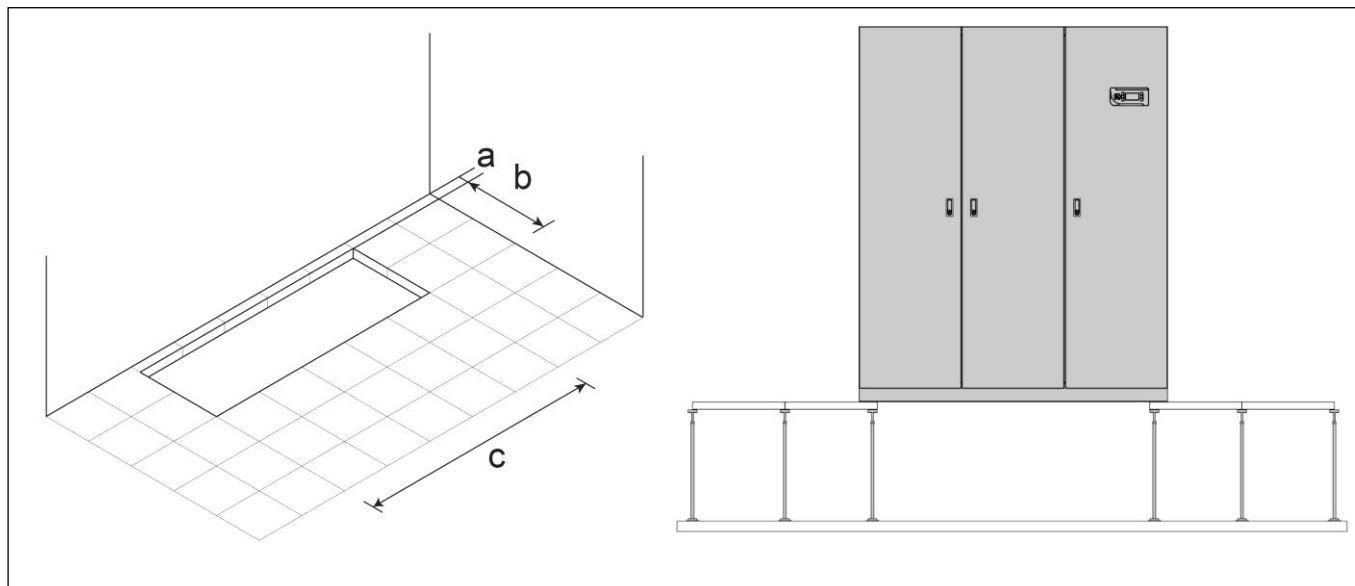

Foresee a hole in the floor with the following dimensions:

SIZE		E1	E2	E3	E4L	E5L	E7L	E8L	E9L
a	mm	95	95	95	110	110	110	110	110
b	mm	560	560	660	785	785	785	785	785
c	mm	560	695	995	1510	1835	2400	2780	3180

HOLE IN THE RAISED FLOOR WITH FLOOR STAND (OPTION)

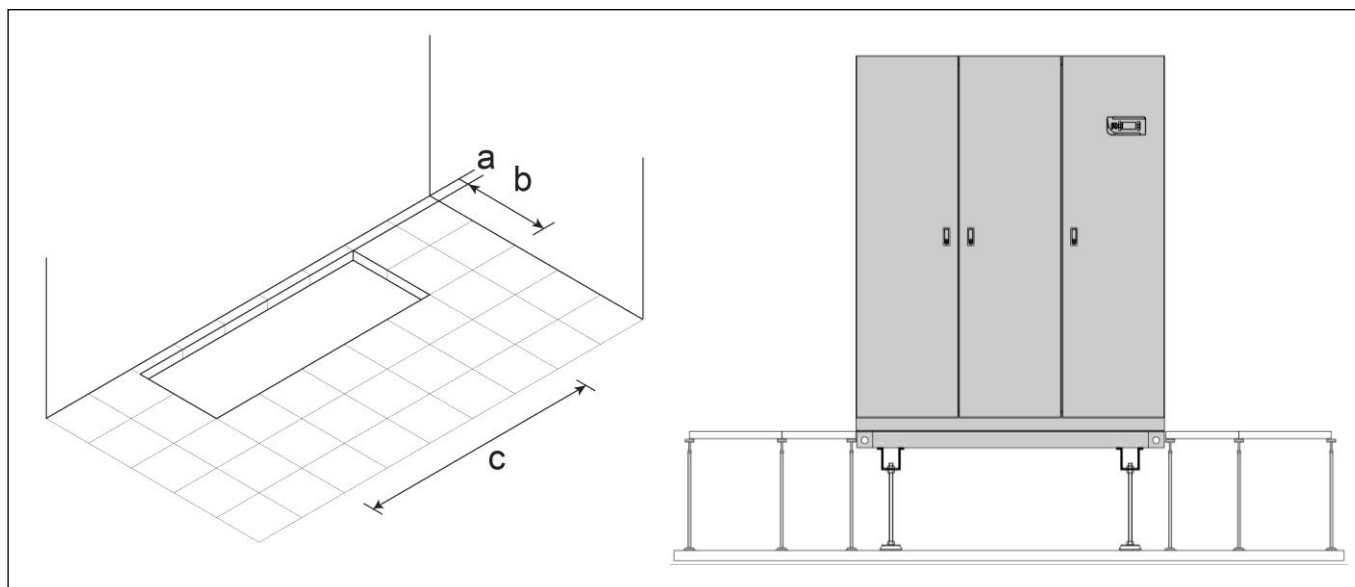

Foresee a hole in the floor with the following dimensions:

SIZE		E1	E2	E3	E4L	E5L	E7L	E8L	E9L
a	mm	50	50	50	50	50	50	50	50
b	mm	670	670	770	925	925	925	925	925
c	mm	670	805	1105	1650	1975	2520	2920	3320

EXAMPLE FOR MACHINES NOISE EMISSION CALCULATION

UNDER MACHINE WITH DUCT ON AIR INTAKE

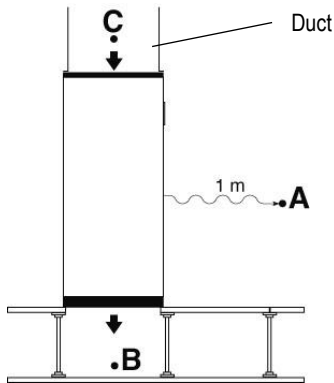

- Lp A = Front side Under catalogue value
- Lp B = Air delivery Under catalogue value
- Lp C = Air intake Under catalogue value
- The points B and C do not influence the point A

UNDER MACHINE WITH PLENUM ON AIR DELIVERY

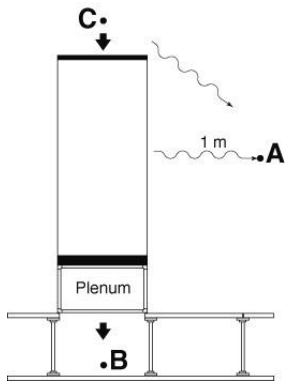

- Lp A = Front side Under catalogue value
- Lp B = Air delivery Under catalogue value – plenum noise reduction
- Lp C = Air intake Under catalogue value
- $Lp A+C = 10 \log_{10} \left(10^{\frac{LpA}{10}} + 10^{\frac{LpC}{10}} \right)$
- The point B do not influence the point A

UNDER MACHINE WITH PLENUM ON AIR INTAKE

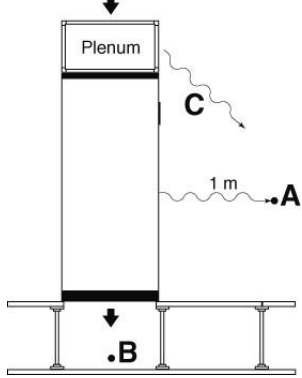

- Lp A = Front side Under catalogue value
- Lp B = Air delivery Under catalogue value
- Lp C = Air intake Under catalogue value – plenum noise reduction
- $Lp A+C = 10 \log_{10} \left(10^{\frac{LpA}{10}} + 10^{\frac{LpC}{10}} \right)$
- The point B do not influence the point A

OVER MACHINE WITH DUCT

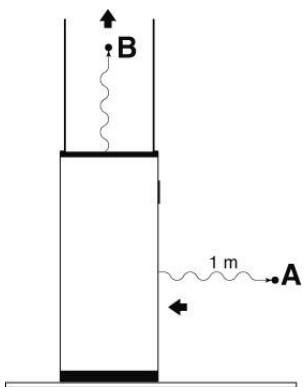

- Lp A = Air intake Over catalogue value
- Lp B = Air delivery Over catalogue value
- The point B do not influence the point A

EXAMPLE FOR MACHINES NOISE EMISSION CALCULATION

OVER MACHINE WITH PLENUM ON AIR DELIVERY

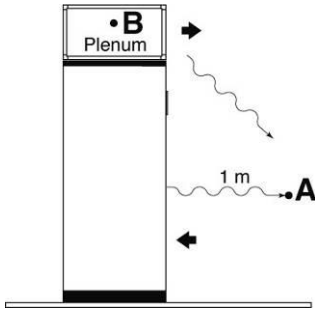

Lp A = Air intake Over catalogue value

Lp B = Air delivery Over catalogue value – plenum noise reduction

$$Lp A+B = 10 \log_{10} \left(10^{\frac{LpA}{10}} + 10^{\frac{LpC}{10}} \right)$$

OVER MACHINE WITH DUCT AND PLENUM ON AIR DELIVERY

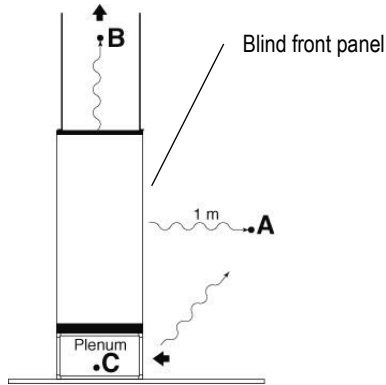

Lp A = Radiated Over catalogue value

Lp B = Air delivery Over catalogue value

Lp C = Lp A + 6dB(A) – plenum noise reduction

$$Lp A+C = 10 \log_{10} \left(10^{\frac{LpA}{10}} + 10^{\frac{LpC}{10}} \right)$$

The point B do not influence the point A+C

OVER MACHINE WITH DUCT AND PLENUM ON AIR DELIVERY

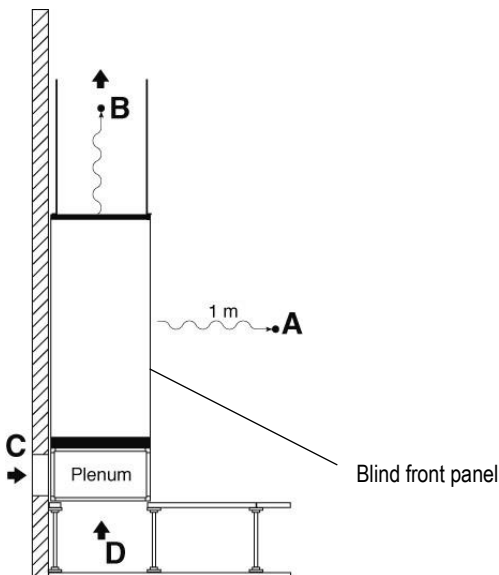

Lp A = Radiated Over catalogue value

Lp B = Air delivery Over catalogue value

Lp C = Lp D = Lp A + 6 dB(A) – plenum noise reduction

The points B, C and D do not influence the point A

IMPORTANT

The declared noise levels are intended in free field conditions.
 The noise pressure level of an installed unit is affected by the room acoustic characteristics.
 Please consider an average noise increase of +4/+6 dB(A).

VALVE PRESSURE DROP CALCULATION AS FUNCTION OF WATER FLOW RATE

Flow coefficient k_v defines the water flow (between 5°C and 40°C) expressed in m³/h that cross a valve with a pressure drop of 1bar (100kPa).

With this data is possible to calculate the localized pressure drop as function of the water flow rate.

$$\Delta P = (Q / k_v)^2$$

ΔP (bar) = localized pressure drop of valve;

Q (m³/h) = water flow rate – it varies according to the desired operating condition;

k_v (m³/h) = valve flow coefficient.

The formula allows to calculate the value of the localized pressure drop (in bar).

The pressure drops values showed on the documentation are supplied in kPa.

Is possible to change from one unit to another through the following conversion.

$$1 \text{ bar} = 100\text{kPa}$$

CALCULATION EXAMPLE OF CONDENSING CONTROL VALVE PRESSURE DROP IN FUNCTION OF CONDENSER WATER FLOW RATE.

Model 068 M2 D E7L – Nom Cooling Capacity

Example at nominal conditions. Characteristics referred to entering air at 26°C-40%UR; water to the condenser 30-36°C

Condenser water flow rate: 14,8 m³/h

Condenser pressure drop 22 kPa

Valve flow coefficient k_v : 25,0 m³/h

Condensing control valve pressure drop: $\Delta P = (Q / k_v)^2 = (14,8 / 25)^2 = 0,350 \text{ (bar)} * 100 \text{ (kPa / bar)} = 35,0 \text{ kPa}$

Pressure drop (condenser + valve) = 22 + 35,0 = 57,0 kPa

AIR FILTERS REPLACEMENT FOR UNDER VERSION MACHINES SIZE E4L – E5L – E7L – E8L – E9L

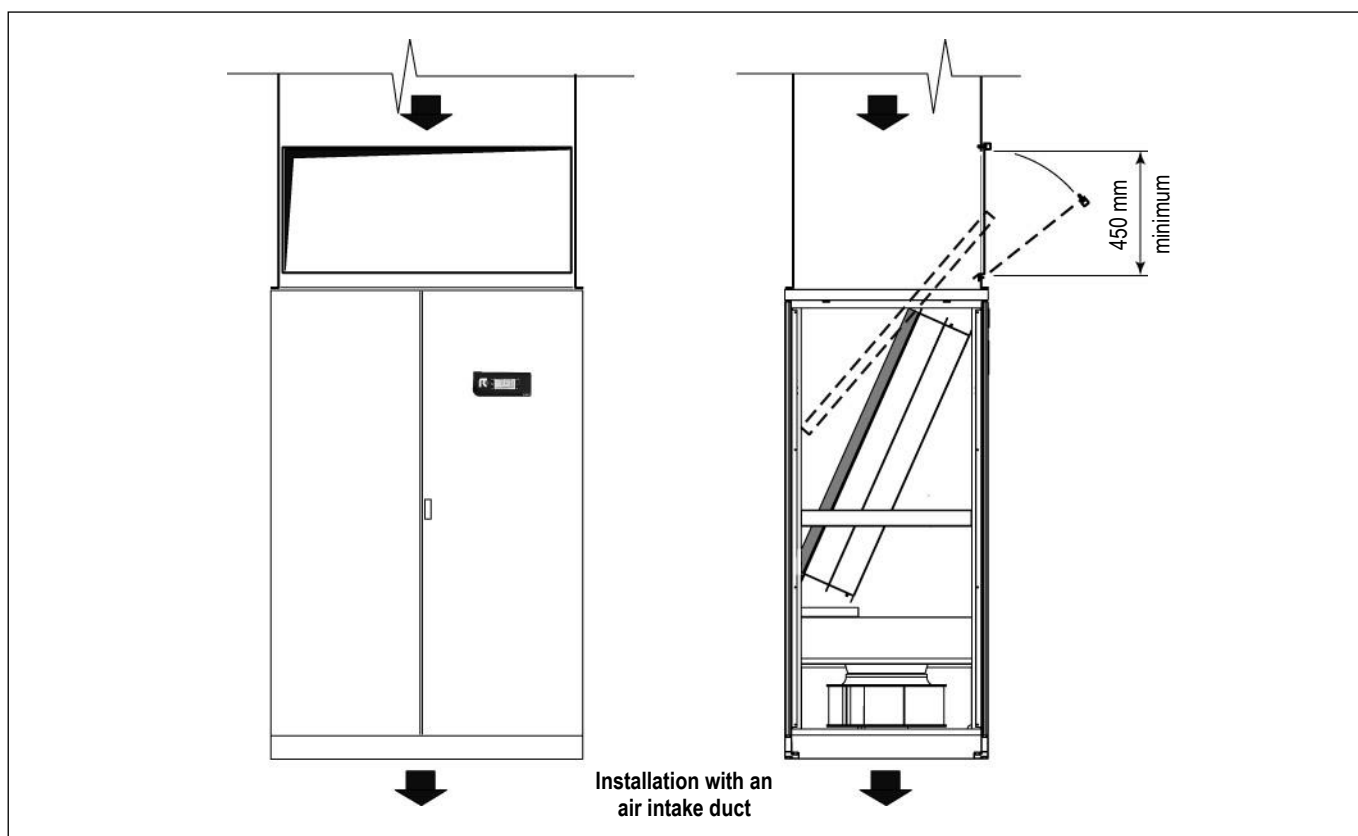
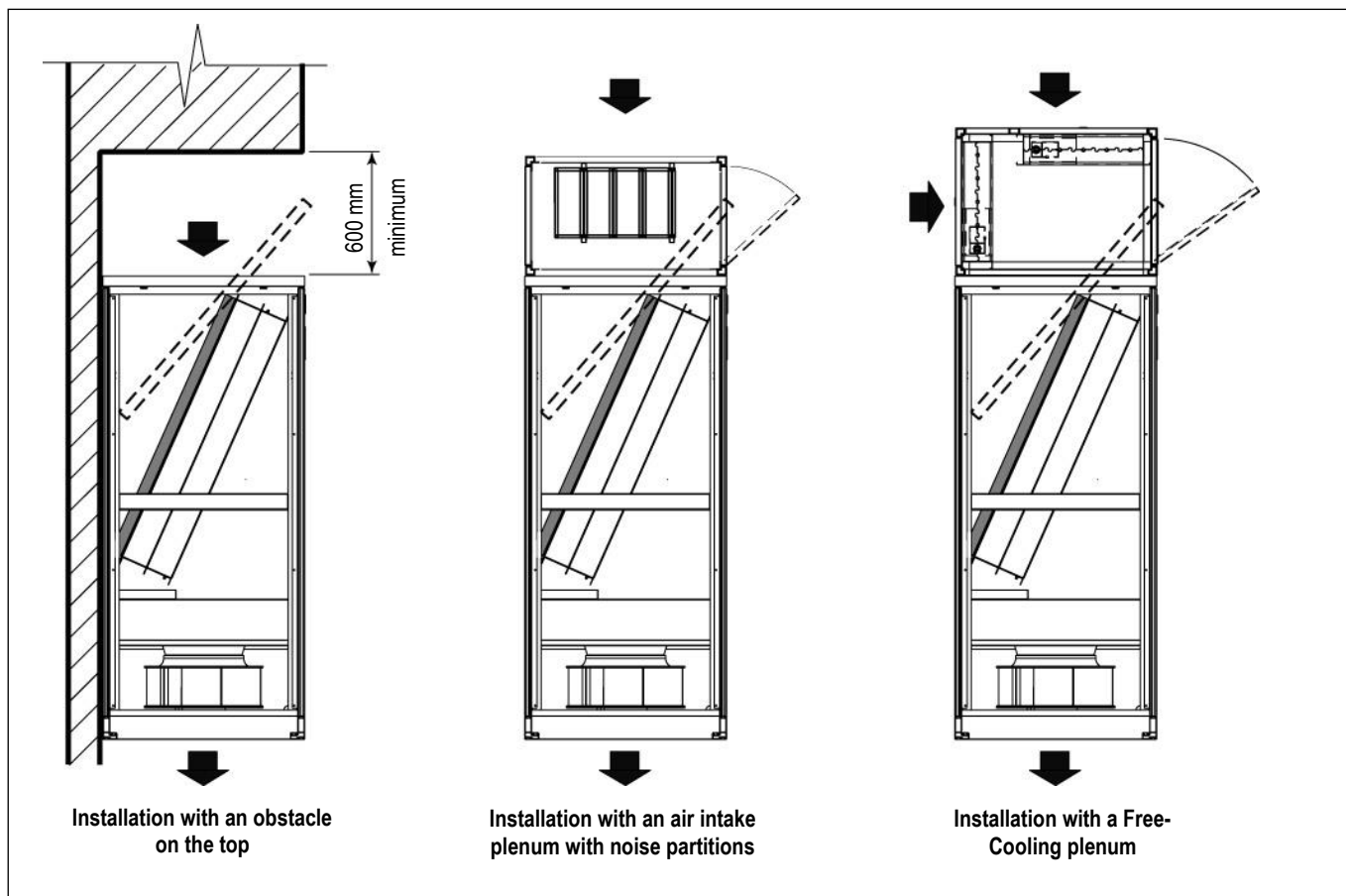



for a greener tomorrow

Eco Changes is the Mitsubishi Electric Group's environmental statement, and expresses the Group's stance on environmental management. Through a wide range of businesses, we are helping contribute to the realization of a sustainable society.



MITSUBISHI ELECTRIC HYDRONICS & IT COOLING SYSTEMS S.p.A.

Via Caduti di Cefalonia, 1 - 36061 Bassano del Grappa (VI) Italy
Ph. (+39) 0424 509 500 • Fax (+39) 0424 509 509
www.melcohit.com